

Rimoldi® & CF

RIMOLDI GENUINE CONVERSION KITS CATALOGUE

CATALOGUE DES KITS DE CONVERSION ORIGINAUX RIMOLDI

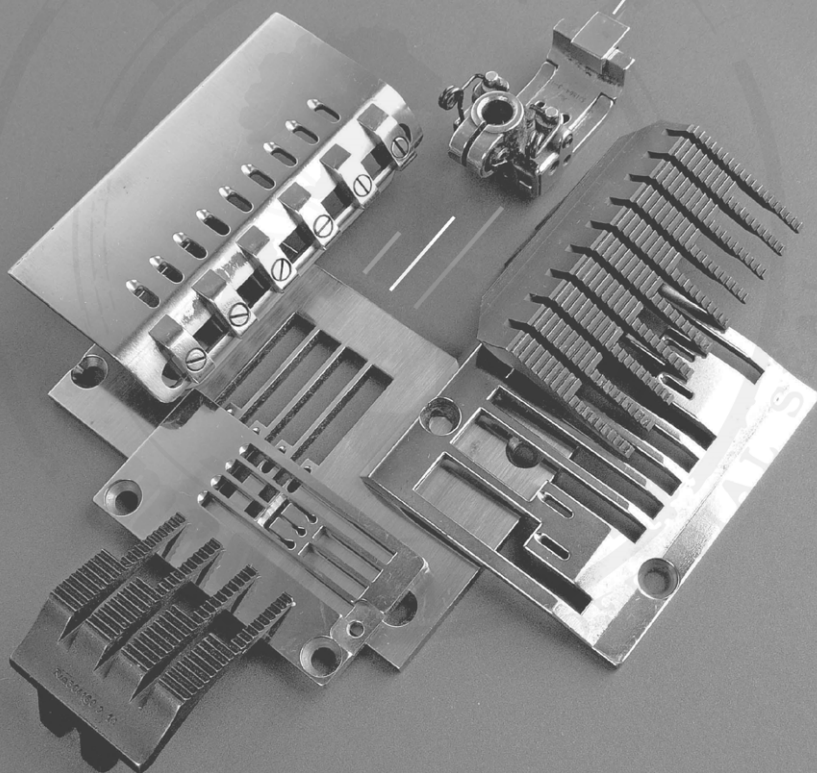



CATALOGO DE TRANSFORMACIONES ORIGINALES RIMOLDI







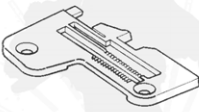
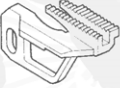

Rimoldi & CF that's Italia!

CATALOGO TRASFORMAZIONI ORIGINALI RIMOLDI



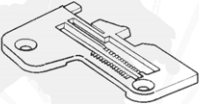
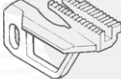



TRASFORMAZIONI ORIGINALI RIMOLDI - GENUINE RIMOLDI CONVERSION KITS

HEAD	MACHINES
	<ul style="list-style-type: none"> <li><b>IT TESTA</b> 327.00.1CD.01</li> <li><b>EN HEAD</b> 527.00.1CD.01</li> <li><b>F TETE</b> 627.00.1CD.01</li> <li><b>ES CABEZAL</b> F27.00.1CD.01</li> </ul>
	<p><b>P202171312</b></p>
	<p><b>P202504011 mm. 4,1</b>  <b>P202148011 mm. 4,6</b>  <b>P202507011 mm. 5,0</b>  <b>P202508011 mm. 5,6</b>  <b>P202590011 mm. 6,0</b>  <b>P211354000 mm. 6,5</b></p>
	<p><b>P202053010</b></p>
	<p><b>P202057020</b></p>
	<p><b>P202061010</b></p>

**TRASFORMAZIONI ORIGINALI RIMOLDI - GENUINE RIMOLDI CONVERSION KITS**

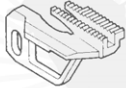
HEAD	MACHINES												
	<table border="0"> <tr> <td data-bbox="400 252 423 276">IT</td> <td data-bbox="428 252 490 276">TESTA</td> <td data-bbox="652 260 787 284">327.00.1CD.07</td> </tr> <tr> <td data-bbox="400 284 423 308">EN</td> <td data-bbox="428 284 484 308">HEAD</td> <td data-bbox="652 292 787 316">527.00.1CD.07</td> </tr> <tr> <td data-bbox="400 316 423 339">F</td> <td data-bbox="428 316 479 339">TETE</td> <td data-bbox="652 323 787 347">627.00.1CD.07</td> </tr> <tr> <td data-bbox="400 347 423 371">ES</td> <td data-bbox="428 347 518 371">CABEZAL</td> <td data-bbox="652 347 787 371">F27.00.1CD.07</td> </tr> </table>	IT	TESTA	327.00.1CD.07	EN	HEAD	527.00.1CD.07	F	TETE	627.00.1CD.07	ES	CABEZAL	F27.00.1CD.07
IT	TESTA	327.00.1CD.07											
EN	HEAD	527.00.1CD.07											
F	TETE	627.00.1CD.07											
ES	CABEZAL	F27.00.1CD.07											
	<b>P202171312</b>												
	<b>P203214011 mm. 3,3</b> <b>P203217011 mm. 3,8</b> <b>P203218011 mm. 5,0</b> <b>P203220011 mm. 2,8</b>												
 	<b>P203199010</b>  <b>P203201211 gommata rubberized</b>												
 	<b>P202057020</b>  <b>P202060220 gommata rubberized</b>												
	<b>P202061010</b>												

TRASFORMAZIONI ORIGINALI RIMOLDI - GENUINE RIMOLDI CONVERSION KITS

HEAD	MACHINES
 <ul style="list-style-type: none"> <li><span style="border: 1px solid black; border-radius: 50%; padding: 2px;">IT</span> TESTA</li> <li><span style="border: 1px solid black; border-radius: 50%; padding: 2px;">EN</span> HEAD</li> <li><span style="border: 1px solid black; border-radius: 50%; padding: 2px;">F</span> TETE</li> <li><span style="border: 1px solid black; border-radius: 50%; padding: 2px;">ES</span> CABEZAL</li> </ul>	<p>327.00.1CD.31</p> <p>527.00.1CD.31</p> <p>627.00.1CD.31</p> <p>F27.00.1CD.31</p>
	<p>P203162311</p>
	<p>P203219011 mm. 3,8</p>
 	<p>P203199010</p> <p>P203201211 gommata rubberized</p>
 	<p>P202057020</p> <p>P202060220 gommata rubberized</p>
	<p>P202609020</p>

TRASFORMAZIONI ORIGINALI RIMOLDI - GENUINE RIMOLDI CONVERSION KITS

HEAD	MACHINES
	<ul style="list-style-type: none"> <li><b>IT</b> TESTA</li> <li><b>EN</b> HEAD</li> <li><b>F</b> TETE</li> <li><b>ES</b> CABEZAL</li> </ul> <div style="text-align: right; margin-top: 10px;">  </div>
	<p><b>P203162311</b></p>
	<p><b>P212161000 mm. 4,0</b>  <b>P212162000 mm. 6,0</b></p>
	<p><b>P946396000</b></p>
	<p><b>P202057020</b></p>
	<p><b>P202609020</b></p>







TRASFORMAZIONI ORIGINALI RIMOLDI - GENUINE RIMOLDI CONVERSION KITS



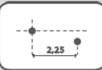

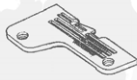



HEAD		MACHINES
IT	TESTA	327.00.2CD.31
EN	HEAD	527.00.2CD.31
F	TETE	627.00.2CD.31
ES	CABEZAL	F27.00.2CD.31

	<b>P208562301</b>
	<b>P208174000 mm. 5,5</b>
	<b>P203199010</b>
	<b>P202057020</b>
	<b>P202609020</b>

TRASFORMAZIONI ORIGINALI RIMOLDI - GENUINE RIMOLDI CONVERSION KITS

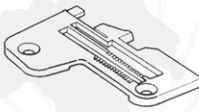
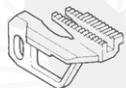



HEAD	MACHINES
	<ul style="list-style-type: none"> <li><b>IT</b> TESTA</li> <li><b>EN</b> HEAD</li> <li><b>F</b> TETE</li> <li><b>ES</b> CABEZAL</li> </ul> <p style="text-align: right;"><b>627.50.2CD.31</b> <b>F27.50.2CD.31</b></p> <p style="text-align: right;"><b>NEW</b></p>
	<p><b>P208562301</b></p>
	<p><b>P212163000 mm. 5,5</b> <b>P212160000 mm. 6,5</b></p>
	<p><b>P946396000</b></p>
	<p><b>P202057020</b></p>
	<p><b>P202609020</b></p>

TRASFORMAZIONI ORIGINALI RIMOLDI - GENUINE RIMOLDI CONVERSION KITS



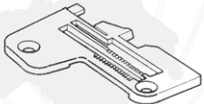
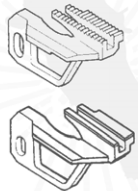
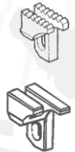

HEAD	MACHINES
	<ul style="list-style-type: none"> <li><b>IT</b> TESTA</li> <li><b>EN</b> HEAD</li> <li><b>F</b> TETE</li> <li><b>ES</b> CABEZAL</li> </ul>
	<p><b>P202178311</b></p>
	<p><b>P202504011</b> mm. 4,1  <b>P202148011</b> mm. 4,6  <b>P202507011</b> mm. 5,0  <b>P202508011</b> mm. 5,6  <b>P202590011</b> mm. 6,0</p>
  	<p><b>P202053010</b></p> <p><b>P202056211</b> gommata rubberized</p>
  	<p><b>P202057020</b></p> <p><b>P202060220</b> gommata rubberized</p>
	<p><b>P202061010</b></p>



TRASFORMAZIONI ORIGINALI RIMOLDI - GENUINE RIMOLDI CONVERSION KITS

HEAD	MACHINES												
	<table border="0"> <tr> <td data-bbox="400 252 423 271">IT</td> <td data-bbox="431 252 490 271">TESTA</td> <td data-bbox="651 263 789 282">327.01.1CD.04</td> </tr> <tr> <td data-bbox="400 284 423 303">EN</td> <td data-bbox="431 284 487 303">HEAD</td> <td data-bbox="651 295 789 314">527.01.1CD.04</td> </tr> <tr> <td data-bbox="400 316 423 335">F</td> <td data-bbox="431 316 479 335">TETE</td> <td data-bbox="651 327 789 346">627.01.1CD.04</td> </tr> <tr> <td data-bbox="400 347 423 367">ES</td> <td data-bbox="431 347 520 367">CABEZAL</td> <td data-bbox="651 359 789 378">F27.01.1CD.04</td> </tr> </table>	IT	TESTA	327.01.1CD.04	EN	HEAD	527.01.1CD.04	F	TETE	627.01.1CD.04	ES	CABEZAL	F27.01.1CD.04
IT	TESTA	327.01.1CD.04											
EN	HEAD	527.01.1CD.04											
F	TETE	627.01.1CD.04											
ES	CABEZAL	F27.01.1CD.04											
	<p data-bbox="651 466 756 485">P202178311</p>												
	<p data-bbox="651 561 828 580">P203214011 mm. 3,3</p> <p data-bbox="651 582 828 601">P203217011 mm. 3,8</p> <p data-bbox="651 603 828 622">P203218011 mm. 5,0</p> <p data-bbox="651 624 828 643">P203220011 mm. 2,8</p>												
	<p data-bbox="651 730 756 750">P203199010</p> <p data-bbox="651 774 856 817">P203201211 gommata rubberized</p>												
	<p data-bbox="651 912 756 932">P202057020</p> <p data-bbox="651 976 856 1019">P202060220 gommata rubberized</p>												
	<p data-bbox="651 1104 756 1123">P202061010</p>												

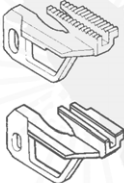
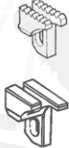

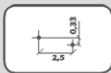

TRASFORMAZIONI ORIGINALI RIMOLDI - GENUINE RIMOLDI CONVERSION KITS

HEAD	MACHINES
	<ul style="list-style-type: none"> <li><b>IT</b> TESTA</li> <li><b>EN</b> HEAD</li> <li><b>F</b> TETE</li> <li><b>ES</b> CABEZAL</li> </ul>
	<p><b>P202178311</b></p>
	<p><b>P203219011 mm. 3,8</b></p>
	<p><b>P203199010</b></p> <p><b>P203201211 gommata rubberized</b></p>
	<p><b>P202057020</b></p> <p><b>P202060220 gommata rubberized</b></p>
	<p><b>P202609020</b></p>



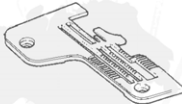



TRASFORMAZIONI ORIGINALI RIMOLDI - GENUINE RIMOLDI CONVERSION KITS





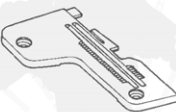

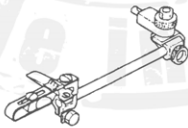

HEAD	MACHINES
IT TESTA	327.01.2MD.07
EN HEAD	527.01.2MD.07
F TETE	627.01.2MD.07
ES CABEZAL	F27.01.2MD.07

	P204028311 P204038301
	P204026011 mm. 7,0 P203578011 mm. 5,5 P204055011 mm. 7,5
	P206298010 mm. 2,0 P203651020 mm. 1,5
	P203609010 mm. 2,0 P203540010 mm. 1,5
	P203612010 mm. 1,5







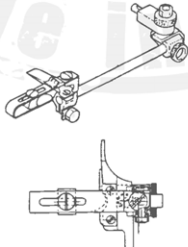

TRASFORMAZIONI ORIGINALI RIMOLDI - GENUINE RIMOLDI CONVERSION KITS

HEAD	MACHINES
	<p>IT <b>TESTA</b></p> <p>EN <b>HEAD</b></p> <p>F <b>TETE</b></p> <p>ES <b>CABEZAL</b></p> <p>327.10.1CD.06</p> <p>527.10.1CD.06</p> <p>627.10.1CD.06</p>
	<p>P202786311</p> <p>P206350300</p>
	<p>P202783011 mm. 3,2</p> <p>P202877011 mm. 5,0</p> <ul style="list-style-type: none"> <li>• P206297001 mm. 3,2</li> <li>• x aghi finezza max 70</li> <li>max needle size 70</li> </ul>
	<p>P202780010</p>
	<p>P202782020</p>
	<p>P202061010</p>
	<p>P203712511</p>





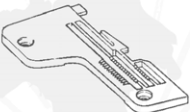
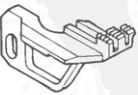
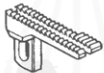

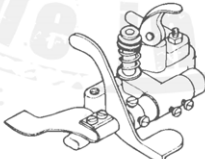
TRASFORMAZIONI ORIGINALI RIMOLDI - GENUINE RIMOLDI CONVERSION KITS

HEAD	MACHINES
	<p>IT TESTA EN HEAD F TETE ES CABEZAL</p> <p>F27.10.1CD.06</p>
	<p>P202786311 P206350300 • P201479301 • abbinamenti obbligatori suggested combination</p>
	<p>P202783011 mm. 3,2 P202877011 mm. 5,0 P206297001 mm. 3,2 x aghi finezza max 70 max needle size 70</p>
	<p>P202780010</p>
	<p>P202782020</p>
	<p>P202061010</p>
	<p>P203712511</p> <p>• P201484400 • abbinamenti obbligatori suggested combination</p>

TRASFORMAZIONI ORIGINALI RIMOLDI - GENUINE RIMOLDI CONVERSION KITS

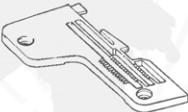
HEAD	MACHINES
 <ul style="list-style-type: none"> <li> <b>TESTA</b></li> <li> <b>HEAD</b></li> <li> <b>TETE</b></li> <li> <b>CABEZAL</b></li> </ul>	<p>327.22.1CD.02 527.22.1CD.02 627.22.1CD.02</p>
	<p>P203157311 P203159311 P203765311</p>
	<p>P203148011 mm. 4,5 P203149011 mm. 5,0 P203150011 mm. 3,5 • P203280011 mm. 2,5 • abbinamenti obbligatori suggested combination</p>
	<p>P203140010 • P203270010 • abbinamenti obbligatori suggested combination</p>
	<p>P203141011 • P203271011 • abbinamenti obbligatori suggested combination</p>
	<p>P202061010</p>
	<p>P204915413</p>

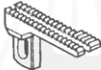
TRASFORMAZIONI ORIGINALI RIMOLDI - GENUINE RIMOLDI CONVERSION KITS

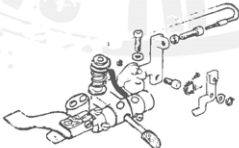

HEAD	MACHINES
	<p>IT TESTA EN HEAD F TETE ES CABEZAL</p> <p>F27.22.1CD.02</p>
	<p>P203157311 P203159311 P203765311</p>
	<p>P203148011 mm. 4,5 P203149011 mm. 5,0 P203150011 mm. 3,5 • P203280011 mm. 2,5 • abbinamenti obbligatori suggested combination</p>
	<p>P203140010 • P203270010 • abbinamenti obbligatori suggested combination</p>
	<p>P203141011 • P203271011 • abbinamenti obbligatori suggested combination</p>
	<p>P202061010</p>
	<p>P211643400</p>

TRASFORMAZIONI ORIGINALI RIMOLDI - GENUINE RIMOLDI CONVERSION KITS





HEAD	MACHINES
	<ul style="list-style-type: none"> <li><b>IT</b> TESTA</li> <li><b>EN</b> HEAD</li> <li><b>F</b> TETE</li> <li><b>ES</b> CABEZAL</li> </ul>
	<p><b>P209536300</b></p>
	<p><b>P209537000 mm. 5,5</b></p>
	<p><b>P209539000</b></p>
	<p><b>P209538000</b></p>
	<p><b>P202609020</b></p>
	<p><b>P211643400</b></p>



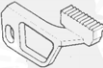

TRASFORMAZIONI ORIGINALI RIMOLDI - GENUINE RIMOLDI CONVERSION KITS

HEAD	MACHINES												
	<table border="0"> <tr> <td data-bbox="400 252 423 276">IT</td> <td data-bbox="428 252 490 276">TESTA</td> <td data-bbox="650 260 781 284">327.28.1CD.07</td> </tr> <tr> <td data-bbox="400 284 423 308">EN</td> <td data-bbox="428 284 484 308">HEAD</td> <td data-bbox="650 292 781 316">527.28.1CD.07</td> </tr> <tr> <td data-bbox="400 316 423 339">F</td> <td data-bbox="428 316 479 339">TETE</td> <td data-bbox="650 316 781 339">627.28.1CD.07</td> </tr> <tr> <td data-bbox="400 347 423 371">ES</td> <td data-bbox="428 347 518 371">CABEZAL</td> <td data-bbox="650 339 781 363">F27.28.1CD.07</td> </tr> </table>	IT	TESTA	327.28.1CD.07	EN	HEAD	527.28.1CD.07	F	TETE	627.28.1CD.07	ES	CABEZAL	F27.28.1CD.07
IT	TESTA	327.28.1CD.07											
EN	HEAD	527.28.1CD.07											
F	TETE	627.28.1CD.07											
ES	CABEZAL	F27.28.1CD.07											
	<p data-bbox="650 469 754 493"><b>P203361311</b></p>												
	<p data-bbox="650 555 837 619"><b>P203354412 mm. 1,3 placca cpt complete needle plate</b></p> <p data-bbox="650 635 754 699"><b>P203357011 linguetta tongue</b></p>												
	<p data-bbox="650 783 754 807"><b>P203335211</b></p>												
	<p data-bbox="650 895 754 919"><b>P203094200</b></p>												
	<p data-bbox="650 1011 754 1035"><b>P202609020</b></p>												

TRASFORMAZIONI ORIGINALI RIMOLDI - GENUINE RIMOLDI CONVERSION KITS

	HEAD	MACHINES
	IT TESTA	327.28.1CD.09
	EN HEAD	527.28.1CD.09
	F TETE	627.28.1CD.09
	ES CABEZAL	F27.28.1CD.09
		P202643311
		P202636011 mm. 1,2
		P202605010
		P202608010
		P202609020

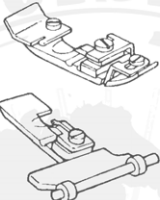
TRASFORMAZIONI ORIGINALI RIMOLDI - GENUINE RIMOLDI CONVERSION KITS

HEAD	MACHINES												
	<table border="0"> <tr> <td data-bbox="400 252 420 272">IT</td> <td data-bbox="431 252 490 272">TESTA</td> <td data-bbox="650 260 784 280">327.34.1CD.01</td> </tr> <tr> <td data-bbox="400 284 420 304">EN</td> <td data-bbox="431 284 487 304">HEAD</td> <td data-bbox="650 288 784 309">527.34.1CD.01</td> </tr> <tr> <td data-bbox="400 316 420 336">F</td> <td data-bbox="431 316 476 336">TETE</td> <td data-bbox="650 316 784 336">627.34.1CD.01</td> </tr> <tr> <td data-bbox="400 347 420 368">ES</td> <td data-bbox="431 347 516 368">CABEZAL</td> <td data-bbox="650 341 784 362">F27.34.1CD.01</td> </tr> </table>	IT	TESTA	327.34.1CD.01	EN	HEAD	527.34.1CD.01	F	TETE	627.34.1CD.01	ES	CABEZAL	F27.34.1CD.01
IT	TESTA	327.34.1CD.01											
EN	HEAD	527.34.1CD.01											
F	TETE	627.34.1CD.01											
ES	CABEZAL	F27.34.1CD.01											
	<p data-bbox="650 469 756 507">P206140302 P203016311</p> <p data-bbox="650 555 784 619">P207116301 per elastico alto for wide elastic</p>												
	<p data-bbox="650 678 828 790">P202504011 mm. 4,1 P202148011 mm. 4,6 P202507011 mm. 5,0 P202508011 mm. 5,6 P202590011 mm. 6,0</p>												
	<p data-bbox="650 868 756 888">P202542010</p>												
	<p data-bbox="650 983 756 1003">P203265011</p>												
	<p data-bbox="650 1098 756 1118">P202061010</p>												

TRASFORMAZIONI ORIGINALI RIMOLDI - GENUINE RIMOLDI CONVERSION KITS

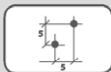

- IT TESTA
- EN HEAD
- F TETE
- ES CABEZAL

**MACHINES**

- 329.00.2CD.06
- 529.00.2CD.06
- 629.00.2CD.06
- F29.00.2CD.06



P205070312

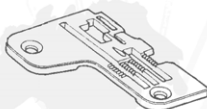

P205025012 mm. 5,5



P205007013  
 • P205060013  
 • abbinamenti obbligatori  
 suggested combination



P205011010  
 • P205065010  
 • abbinamenti obbligatori  
 suggested combination



P202609020

TRASFORMAZIONI ORIGINALI RIMOLDI - GENUINE RIMOLDI CONVERSION KITS

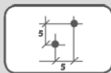

HEAD		MACHINES
IT	TESTA	F29.00.2MD.15
EN	HEAD	
F	TETE	
ES	CABEZAL	

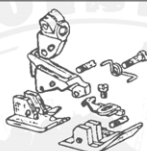

P211081300



P209056001 mm. 9,5



P211091000









P211090000

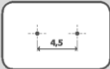
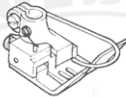
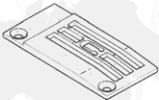







P209058000

TRASFORMAZIONI ORIGINALI RIMOLDI - GENUINE RIMOLDI CONVERSION KITS

HEAD	MACHINES
	<ul style="list-style-type: none"> <li>IT TESTA</li> <li>EN HEAD</li> <li>F TETE</li> <li>ES CABEZAL</li> </ul> <ul style="list-style-type: none"> <li>261.11.2EK.01</li> <li>261.11.2EK.03</li> <li>261.11.2EK.06</li> <li>F61.11.2EK.01</li> <li>F61.11.2EK.06</li> <li>• 61F.11.2EK.01</li> <li>• 61F.11.2EK.06</li> </ul>
	<p>P306669300</p>
	<p>P304052010</p>
	<p>P307702000</p>
 	<p>P309806401</p> <ul style="list-style-type: none"> <li>• P325384200</li> </ul>
 	<p>GO274 - 09  GO274 - 11  GO274 - 14  GO274 - 18  GO274 - 22</p>

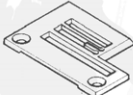







TRASFORMAZIONI ORIGINALI RIMOLDI - GENUINE RIMOLDI CONVERSION KITS

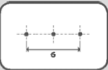



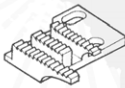
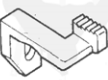

HEAD	MACHINES
	<ul style="list-style-type: none"> <li><b>IT TESTA</b></li> <li><b>EN HEAD</b></li> <li><b>F TETE</b></li> <li><b>ES CABEZAL</b></li> </ul>
	<p><b>P300110320</b> <b>NEW</b></p>
	<p><b>P301760020</b></p>
	<p><b>P321404000</b></p>
	<p><b>P321423000</b></p>
	<p><b>Sirio I P309803400</b></p>
	<p><b>Sirio II P325385200</b></p>







TRASFORMAZIONI ORIGINALI RIMOLDI - GENUINE RIMOLDI CONVERSION KITS

HEAD	MACHINES
	<p>IT TESTA            EN HEAD            F TETE            ES CABEZAL</p> <p>263.16.3MD.08</p> <ul style="list-style-type: none"> <li>• 263.16.3MD.08 versione spostata displaced model</li> </ul>
	<p>P300111314 <b>NEW</b></p>
 	<p>P301764020</p> <ul style="list-style-type: none"> <li>• P313503000</li> </ul>
	<p>P300133021</p>
 	<p>P300135011</p> <ul style="list-style-type: none"> <li>• P313506000</li> </ul>
	<p>P309800401</p>



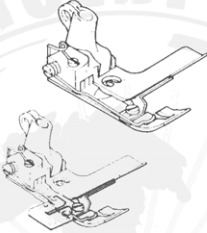
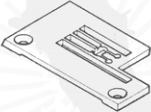

TRASFORMAZIONI ORIGINALI RIMOLDI - GENUINE RIMOLDI CONVERSION KITS

HEAD	MACHINES
	<p>IT TESTA EN HEAD F TETE ES CABEZAL</p> <p>Sirio I F63.16.3MD.08 Sirio II 63F.16.3LD.08</p>
	<p>P300111314 <b>NEW</b></p>
	<p>P313503000</p>
	<p>P321400000</p>
	<p>P321420000</p>
	<p>Sirio I P309800401 Sirio II P325383200</p>



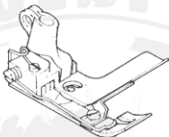
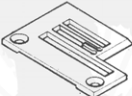

TRASFORMAZIONI ORIGINALI RIMOLDI - GENUINE RIMOLDI CONVERSION KITS

HEAD	MACHINES
	<ul style="list-style-type: none"> <li><b>IT TESTA</b></li> <li><b>EN HEAD</b></li> <li><b>F TETE</b></li> <li><b>ES CABEZAL</b></li> </ul> <p><b>263.34.2DR.20</b></p>
	<p><b>P304407311</b></p> <p><b>P302873312</b></p>
	<p><b>P302811010</b></p>
	<p><b>P302796010</b></p>
	<p><b>P302798010</b></p>
	<p><b>P309803400</b></p>

TRASFORMAZIONI ORIGINALI RIMOLDI - GENUINE RIMOLDI CONVERSION KITS

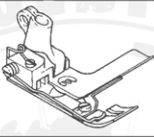
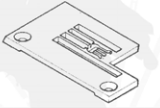
HEAD	MACHINES												
	<table border="0"> <tr> <td data-bbox="400 252 423 272">IT</td> <td data-bbox="434 252 490 272">TESTA</td> <td data-bbox="652 261 857 282">Sirio I F63.34.2DR.20</td> </tr> <tr> <td data-bbox="400 284 423 304">EN</td> <td data-bbox="434 284 490 304">HEAD</td> <td></td> </tr> <tr> <td data-bbox="400 316 423 336">F</td> <td data-bbox="434 316 490 336">TETE</td> <td data-bbox="639 316 857 336">• Sirio II 63F.34.2DR.20</td> </tr> <tr> <td data-bbox="400 347 423 368">ES</td> <td data-bbox="434 347 518 368">CABEZAL</td> <td data-bbox="639 347 857 368">• Sirio II 63F.34:2LR.20</td> </tr> </table>	IT	TESTA	Sirio I F63.34.2DR.20	EN	HEAD		F	TETE	• Sirio II 63F.34.2DR.20	ES	CABEZAL	• Sirio II 63F.34:2LR.20
IT	TESTA	Sirio I F63.34.2DR.20											
EN	HEAD												
F	TETE	• Sirio II 63F.34.2DR.20											
ES	CABEZAL	• Sirio II 63F.34:2LR.20											
	<p>P304407311 P302873312 P304068300</p>												
	<p>P302811010</p>												
	<p>P321402000</p>												
	<p>P321422000</p>												
  	<p>Sirio I P309803400  • Sirio II P325385200</p>												

TRASFORMAZIONI ORIGINALI RIMOLDI - GENUINE RIMOLDI CONVERSION KITS

HEAD	MACHINES
	<ul style="list-style-type: none"> <li><b>IT TESTA</b></li> <li><b>EN HEAD</b></li> <li><b>F TETE</b></li> <li><b>ES CABEZAL</b></li> </ul> <p style="text-align: right;"><b>263.34.3DR.16</b></p>
	<p><b>P304378312</b></p>
	<p><b>P302735010</b></p>
	<p><b>P302795010</b></p>
	<p><b>P302797010</b></p>
	<p><b>P309800401</b></p>

TRASFORMAZIONI ORIGINALI RIMOLDI - GENUINE RIMOLDI CONVERSION KITS

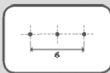

**HEAD**

**MACHINES**

IT TESTA

Sirio I F63.34.3DR.16

EN HEAD

F TETE

• Sirio II 63F.34.3DR.16

ES CABEZAL

• Sirio II 63F.34.3LR.16

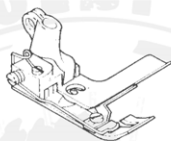

**P304378312**

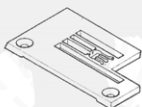

**P302735010**



**P321407000**



**P321428000**







**P309800401**



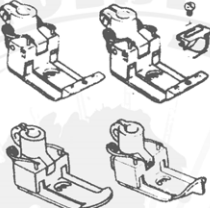
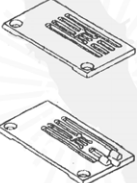





• **P325383200**

TRASFORMAZIONI ORIGINALI RIMOLDI - GENUINE RIMOLDI CONVERSION KITS

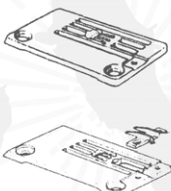





HEAD	MACHINES
	<p>IT TESTA EN HEAD F TETE ES CABEZAL</p> <p>263.46.3MD.05</p> <ul style="list-style-type: none"> <li>• 263.06.3MD.02 ribattitura topstitching</li> </ul>
	<p>P321862311 • P321864311</p> <p>P300581314 • P300583312</p>
	<p>P302416010 P302404011 P302423001 P308836010</p> <ul style="list-style-type: none"> <li>• P302408211</li> </ul>
	<p>P300563012</p>
	<p>P300564012</p> <ul style="list-style-type: none"> <li>• P300576011</li> </ul>
	<p>P309800401</p>

TRASFORMAZIONI ORIGINALI RIMOLDI - GENUINE RIMOLDI CONVERSION KITS

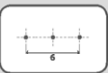

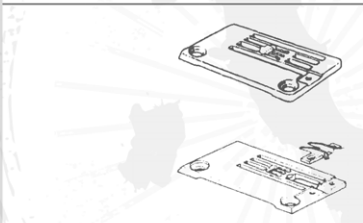

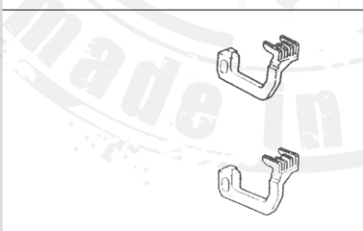

HEAD	MACHINES
	<p>                     IT TESTA                      EN HEAD                      F TETE                      ES CABEZAL                 </p> <p>                     Sirio I F63.46.3MD.05                      • Sirio I F63.06.3MD.02                      ribattitura                      topstitching                 </p>
	<p>                     P321862311                      • P321864311                 </p> <p>                     P300581314                      • P300583312                 </p>
	<p>                     P308836010                      P321450020                 </p> <p>                     • P321459401                 </p>
	<p>P321401000</p>
	<p>P321421000</p> <p>• P321424000</p>
	<p>P309800401</p>





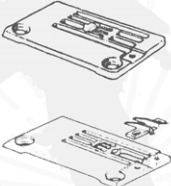



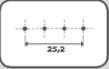
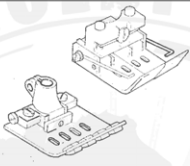
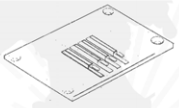
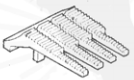

TRASFORMAZIONI ORIGINALI RIMOLDI - GENUINE RIMOLDI CONVERSION KITS

HEAD	MACHINES
	<p>IT TESTA EN HEAD F TETE ES CABEZAL</p> <p>Sirio II 63F.46.3MD.05</p> <ul style="list-style-type: none"> <li>Sirio II 63F.06.3LD.02 ribattitura topstitching</li> </ul>
	<p>P321862311</p> <ul style="list-style-type: none"> <li>P321864311</li> </ul>
	<p>P308836010 P321450020</p> <ul style="list-style-type: none"> <li>P321459401</li> </ul>
	<p>P321401000</p>
	<p>P321421000</p> <ul style="list-style-type: none"> <li>P321424000</li> </ul>
	<p>P325383200</p>

TRASFORMAZIONI ORIGINALI RIMOLDI - GENUINE RIMOLDI CONVERSION KITS

HEAD	MACHINES
	<p>IT TESTA EN HEAD F TETE ES CABEZAL</p> <p>Sirio II 63F.66.3LD.15 ribattitura destra ,sinistra e orlatura right,left topstitching and hemming • ribattitura centrale central topstitching</p>
	<p>P321864311</p>
	<p>P321450020 ribattitura destra e sinistra right and left topstitching P306896401 orlatura hemming</p> <p>• P321459401 ribattitura centrale central topstitching</p>
	<p>P321401000</p>
	<p>P321421000</p>
	<p>• P321424000</p>
	<p>P325383200</p>







TRASFORMAZIONI ORIGINALI RIMOLDI - GENUINE RIMOLDI CONVERSION KITS

HEAD	MACHINES
	<p>IT TESTA EN HEAD F TETE ES CABEZAL</p> <p>264.11.4EL.09</p>
	<p>P306672301 P306672320</p>
	<p>P304198011</p>
	<p>P304160010</p>
	<p>P304146410</p>
	<p>P304834000</p>
	<p>P304830300</p>
	<p>P304832000</p>
	<p>P304187020</p>
 	<p>GO273 - 32</p>

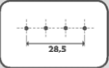
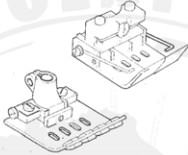
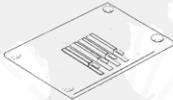





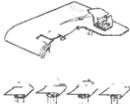

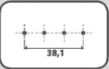
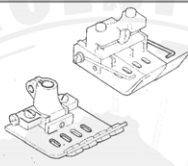

TRASFORMAZIONI ORIGINALI RIMOLDI - GENUINE RIMOLDI CONVERSION KITS

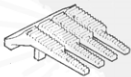
HEAD	MACHINES
	<p>IT <b>TESTA</b>                  EN <b>HEAD</b>                  F <b>TETE</b>                  ES <b>CABEZAL</b></p> <p>264.11.4EL.10</p>
	<p>P306673301</p> <p>P306673320</p>
	<p>P304199011</p>
	<p>P304161010</p>
	<p>P304148410</p>
	<p>P304833000</p>
	<p>P304830300</p>
	<p>P304832000</p>
	<p>P304187020</p>
	<p>GO273 - 26</p>









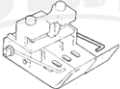

TRASFORMAZIONI ORIGINALI RIMOLDI - GENUINE RIMOLDI CONVERSION KITS

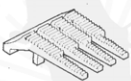
HEAD	MACHINES
	<ul style="list-style-type: none"> <li><b>IT</b> TESTA</li> <li><b>EN</b> HEAD</li> <li><b>F</b> TETE</li> <li><b>ES</b> CABEZAL</li> </ul>
	<p><b>P306674301</b></p>
	<p><b>P306674320</b></p>
	<p><b>P304200011</b></p>
	<p><b>P304162010</b></p>
	<p><b>P304150410</b></p>
	<p><b>P304835000</b></p>
	<p><b>P304830300</b></p>
	<p><b>P304832000</b></p>
	<p><b>P304187020</b></p>
	<p><b>GO273 - 35</b></p>

TRASFORMAZIONI ORIGINALI RIMOLDI - GENUINE RIMOLDI CONVERSION KITS







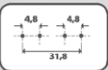

HEAD	MACHINES
	<p>IT TESTA EN HEAD F TETE ES CABEZAL</p> <p>264.11.4EL.12</p>
	<p>P306675301</p> <p>P306675320</p>
	<p>P304201011</p>
	<p>P304163010</p>
	<p>P304152410</p>
	<p>P304837000</p>
	<p>P304830300</p>
	<p>P304832000</p>
	<p>P304187020</p>
 	<p>GO273 - 45</p>

TRASFORMAZIONI ORIGINALI RIMOLDI - GENUINE RIMOLDI CONVERSION KITS

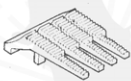
HEAD	MACHINES
	<ul style="list-style-type: none"> <li><b>IT</b> TESTA</li> <li><b>EN</b> HEAD</li> <li><b>F</b> TETE</li> <li><b>ES</b> CABEZAL</li> </ul>
	<p><b>P306088311</b></p>
	<p><b>P306087011</b></p>
	<p><b>P306082010</b></p>
	<p><b>P306081410</b></p>
	<p><b>P304836000</b></p>
	<p><b>P304830300</b></p>
	<p><b>P304832000</b></p>
	<p><b>P304187020</b></p>
	<p><b>GO273 - 38</b></p>
	

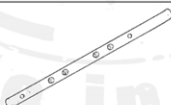

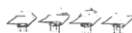

**3**

TRASFORMAZIONI ORIGINALI RIMOLDI - GENUINE RIMOLDI CONVERSION KITS



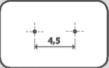
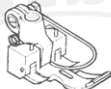
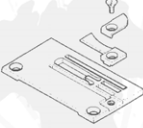



HEAD	MACHINES
	<p>IT TESTA EN HEAD F TETE ES CABEZAL</p> <p>264.11.4EL.16</p>
	<p>P306726301</p>
	<p>P304539011</p>
	<p>P304524010</p>
	<p>P304519410</p>
	<p>P304838000</p>
	<p>P304830300</p>
	<p>P304832000</p>
	<p>P304187020</p>
 	<p>GO273 - 38</p>



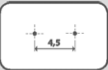









TRASFORMAZIONI ORIGINALI RIMOLDI - GENUINE RIMOLDI CONVERSION KITS

HEAD	MACHINES																		
	<table border="0"> <tr> <td data-bbox="400 248 423 272">IT</td> <td data-bbox="434 248 490 272">TESTA</td> <td data-bbox="650 248 781 272">171.10.2MD.01</td> </tr> <tr> <td data-bbox="400 280 423 304">EN</td> <td data-bbox="434 280 490 304">HEAD</td> <td data-bbox="650 280 781 304">271.10.2MD.01</td> </tr> <tr> <td data-bbox="400 312 423 336">F</td> <td data-bbox="434 312 490 336">TETE</td> <td data-bbox="639 312 848 336">• 171.10.2MD.01/538.10</td> </tr> <tr> <td data-bbox="400 344 423 368">ES</td> <td data-bbox="434 344 524 368">CABEZAL</td> <td data-bbox="639 344 848 368">• 271.10.2MD.01/538.11</td> </tr> <tr> <td></td> <td></td> <td data-bbox="639 376 848 400">• 271.10.2MD.01/538.12</td> </tr> <tr> <td></td> <td></td> <td data-bbox="639 392 848 416">• 271.10.2MD.01/558.12</td> </tr> </table>	IT	TESTA	171.10.2MD.01	EN	HEAD	271.10.2MD.01	F	TETE	• 171.10.2MD.01/538.10	ES	CABEZAL	• 271.10.2MD.01/538.11			• 271.10.2MD.01/538.12			• 271.10.2MD.01/558.12
IT	TESTA	171.10.2MD.01																	
EN	HEAD	271.10.2MD.01																	
F	TETE	• 171.10.2MD.01/538.10																	
ES	CABEZAL	• 271.10.2MD.01/538.11																	
		• 271.10.2MD.01/538.12																	
		• 271.10.2MD.01/558.12																	
	P306625301																		
	P302512413																		
	P311261001																		
 	P302493011	• P924526001																	
	P309806401																		

TRASFORMAZIONI ORIGINALI RIMOLDI - GENUINE RIMOLDI CONVERSION KITS

HEAD	MACHINES																		
	<table border="0"> <tr> <td data-bbox="400 252 423 272">IT</td> <td data-bbox="434 252 490 272">TESTA</td> <td data-bbox="650 252 781 272">171.10.2MD.04</td> </tr> <tr> <td data-bbox="400 284 423 304">EN</td> <td data-bbox="434 284 490 304">HEAD</td> <td data-bbox="650 284 781 304">271.10.2MD.04</td> </tr> <tr> <td data-bbox="400 316 423 336">F</td> <td data-bbox="434 316 490 336">TETE</td> <td data-bbox="639 316 848 336">• 171.10.2MD.04/538.10</td> </tr> <tr> <td data-bbox="400 347 423 368">ES</td> <td data-bbox="434 347 524 368">CABEZAL</td> <td data-bbox="639 347 848 368">• 271.10.2MD.04/538.11</td> </tr> <tr> <td></td> <td></td> <td data-bbox="639 379 848 400">• 271.10.2MD.04/538.12</td> </tr> <tr> <td></td> <td></td> <td data-bbox="639 411 848 432">• 271.10.2MD.04/558.12</td> </tr> </table>	IT	TESTA	171.10.2MD.04	EN	HEAD	271.10.2MD.04	F	TETE	• 171.10.2MD.04/538.10	ES	CABEZAL	• 271.10.2MD.04/538.11			• 271.10.2MD.04/538.12			• 271.10.2MD.04/558.12
IT	TESTA	171.10.2MD.04																	
EN	HEAD	271.10.2MD.04																	
F	TETE	• 171.10.2MD.04/538.10																	
ES	CABEZAL	• 271.10.2MD.04/538.11																	
		• 271.10.2MD.04/538.12																	
		• 271.10.2MD.04/558.12																	
	<p data-bbox="650 467 759 488"><b>P306611300</b></p>																		
	<p data-bbox="650 571 759 592"><b>P302626402</b></p> <p data-bbox="650 603 759 624"><b>P302510412</b></p> <p data-bbox="650 635 759 655"><b>P302510420</b></p>																		
	<p data-bbox="650 722 759 743"><b>P311261001</b></p>																		
 	<p data-bbox="650 850 759 871"><b>P302491011</b></p> <p data-bbox="639 914 759 935">• <b>P924509011</b></p>																		
	<p data-bbox="650 1048 759 1069"><b>P309806401</b></p>																		





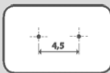

TRASFORMAZIONI ORIGINALI RIMOLDI - GENUINE RIMOLDI CONVERSION KITS

HEAD	MACHINES
	<ul style="list-style-type: none"> <li><b>IT TESTA</b> 273.10.3MD.01/517.11</li> <li><b>EN HEAD</b> 273.10.3MD.01/517.12</li> <li><b>F TETE</b> 273.10.3MD.01/557.12</li> <li><b>ES CABEZAL</b> • F73.10.3MD.01/557.12</li> </ul>
	<p><b>P322474300</b></p>
	<p><b>P302078314</b></p>
	<p><b>P302067410</b></p>
	<p>• <b>P322490400</b></p>
	<p><b>P311262001</b></p>
	<p>• <b>P311261001</b></p>
	<p><b>P924499000</b></p>
	<p>• <b>P924509011</b></p>
	<p><b>P309806401</b></p>

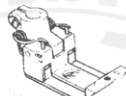
TRASFORMAZIONI ORIGINALI RIMOLDI - GENUINE RIMOLDI CONVERSION KITS

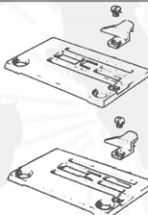



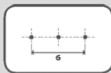

HEAD		MACHINES
IT	TESTA	273.10.2MD.04/517.11
EN	HEAD	273.10.2MD.04/517.12
F	TETE	273.10.2MD.04/557.12
ES	CABEZAL	• F73.10.2MD.04/557.12

	<b>P322476300</b>
	<b>P306611300</b>
	<b>P302706411</b> • P302510412
	<b>P315252001</b>
	• P311261001
	<b>P924509011</b>
	<b>P309806401</b>

TRASFORMAZIONI ORIGINALI RIMOLDI - GENUINE RIMOLDI CONVERSION KITS

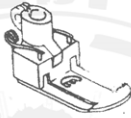

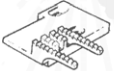
	HEAD	MACHINES
IT	TESTA	F71.10.3MR.02/558.12
EN	HEAD	71F.10.3MR.02/558.12
F	TETE	• F73.10.3MR.02/557.12
ES	CABEZAL	• 73F.10.3MR.02/557.12

	<p><b>P302656311</b></p>
	<p>• <b>P321862311</b></p>
	<p><b>P322492400</b></p>
	<p><b>P311262001</b></p>
	<p><b>P924539001</b></p>
	<p><b>P309800401</b></p>

# RIMOLDI & CF that's Italia!

## NEW!!

TRASFORMAZIONI ORIGINALI RIMOLDI –GENUINE RIMOLDI CONVERSION KITS

FOR: 327-28-1CD-08

527-28-1CD-08

627-28-1CD-08

F27-28-1CD-08

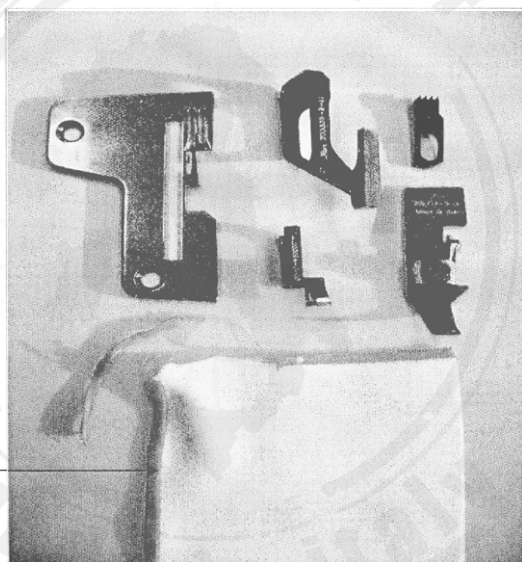







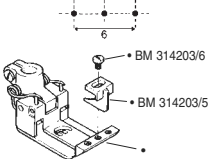
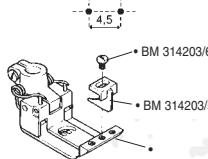
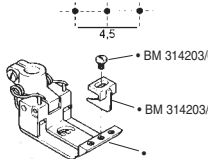
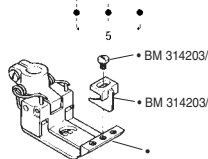
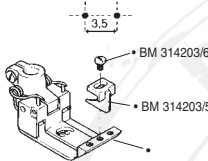
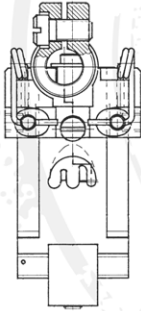

Misura costa  
overedge width 2,5 mm  
Elastico  
elastic size 2 mm

DESCRIZIONE/DESCRIPTION	CODICE/CODE
Placca – needle plate	P202640010
Griffa anteriore - front feed dog	P203335211
Griffa posteriore – rear feed dog	P203094200
Grifino – feed dog	P202609020
Piedino – foot	P202724300

Surfilitura ornamentale del tessuto di maglia, jersey (etc,etc...) con inserimento di elastico  
Ornamental overedging for knitwear, jersey (etc,etc...)with elastic insertion

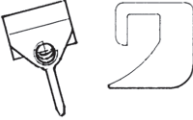

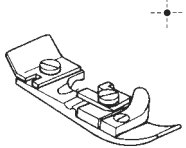
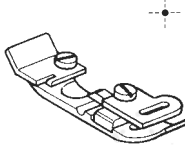
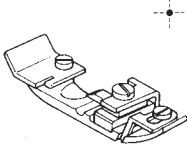
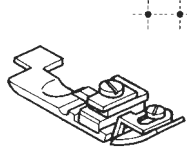
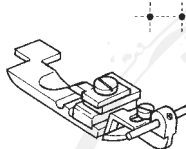
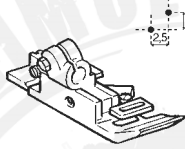
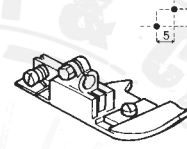
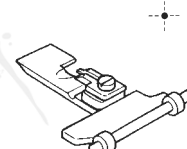
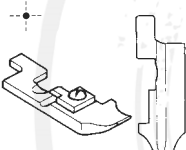
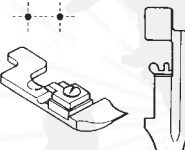
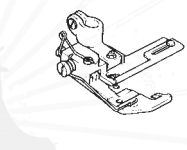
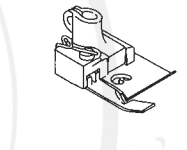
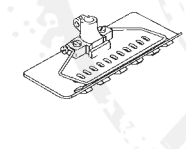
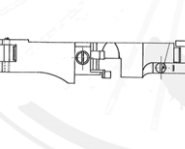
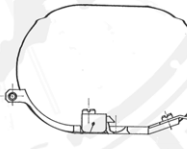







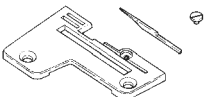
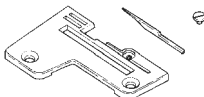
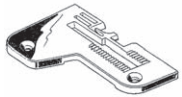

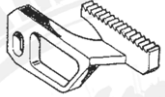
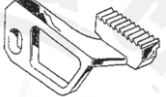
[www.rimoldiecf.com](http://www.rimoldiecf.com) – [info@rimoldiecf.com](mailto:info@rimoldiecf.com)

<p><b>VARIOUS PRESSER FEET</b></p>	<p><b>PIEDINI VARI</b></p>	<p><b>PIEDS DE BICHE DIVERS</b></p>	<p><b>PRENSATELAS VARIAS</b></p>
 <p>• = BM 314203/1</p>	 <p>• = BM 314203/2</p>	 <p>• = BM 314203/3</p>	 <p>• = BM 314203/4</p>
 <p>• = BM 314203/7</p>			
	 <p>3 needles 6 mm P321864311</p>	 <p>3 needles 4,5 mm P322497300</p>	 <p>3 needles 5 mm P322483300</p>
	 <p>2 needles 4,5 mm P322476300 without plough</p>	 <p>3 needles 6 mm P322479300</p>	
			 <p>P325460200 plough P325461200</p>





<p><b>VARIOUS PRESSER FEET</b></p>	<p><b>PIEDINI VARI</b></p>	<p><b>PIEDS DE BICHE DIVERS</b></p>	<p><b>PRENSATELAS VARIAS</b></p>
 <p>P202172311 (teflon)</p>	 <p>P202178311 el. mm 9</p>	 <p>P203016311 el. mm 12</p>	 <p>P204028311 el. mm 12</p>
 <p>BM 204028/1</p>	 <p>P204951312</p>	 <p>P206002302</p>	 <p>P207116301</p>
 <p>BM 6001</p>	 <p>BM 6002</p>	 <p>P30447311</p>	 <p>P300145313</p>
 <p>P313382300</p>	 <p>P208365300</p>	 <p>P208365300</p>	 <p>P208364000 belt</p>

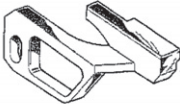
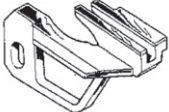
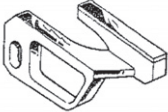
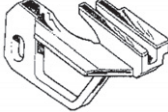

TRASFORMAZIONE CORDONETTO / CORD CONVERSION KIT

 <p>P203354412 placca P203357001 ling. P203382010 vite</p>	 <p>P203354412 placca P203357001 ling. P203382010 vite</p>	 <p>P202636011</p>	
 <p>P203335211</p>	 <p>P202604010</p>	 <p>P202605010</p>	
 <p>P203094200</p>	 <p>P202607010</p>	 <p>P202608010</p>	
 <p>P202609020</p>	 <p>P202609020</p>	 <p>P202609020</p>	
 <p>P203361311</p>	 <p>P203361311</p>	 <p>P202643311</p>	

**TRASFORMAZIONE CORDONETTO / CORD CONVERSION KIT**

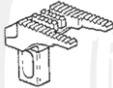
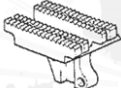
 <p>P203005200</p>	 <p>P203201211</p>	 <p>P203335211</p>	 <p>P202058211</p>
 <p>P203094200</p>	 <p>P202060211</p>	 <p>P203004200</p>	 <p>P202060211</p>
 <p>P350123010</p>	 <p>P350122210</p>		