

Rimoldi









Rimoldi

Rimoldi

Rimoldi









GL1-66-4MD-15 left

GR1-66-4MD-15 right

MACHINE							SEWING
GL1-66-4MD-15 GR1-66-4MD-15	RIM 63 	5	5	0.8÷2		5000	









GL4-16-1MA-26 left

GR4-16-1MA-26 right

MACHINE							SEWING
GL4-16-1MA-26 GR4-16-1MA-26	RIM 63 	2	5	0.8÷2		5000	

GL1-00-2LA-64 left

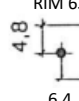
GR1-00-2LA-64 right

MACHINE						
GL1-00-2LA-64 GR1-00-2LA-64	RIM 63 	4	3	0.8÷2		5500

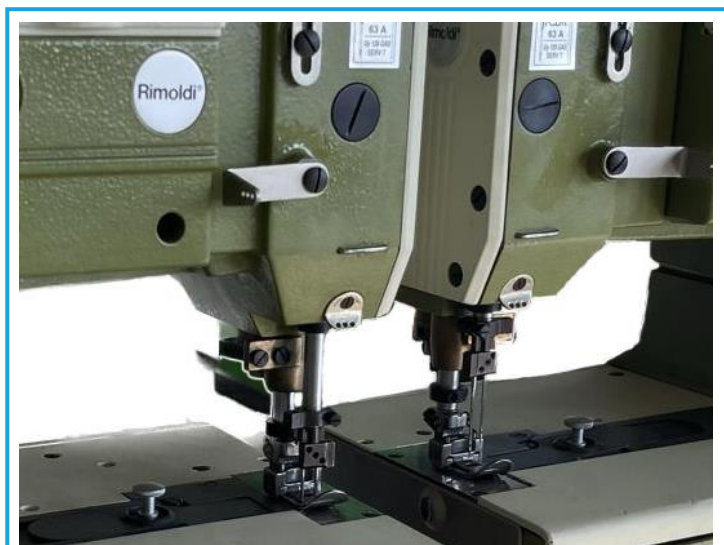

Rimoldi

Rimoldi

Rimoldi

Rimoldi