

Rimoldi®

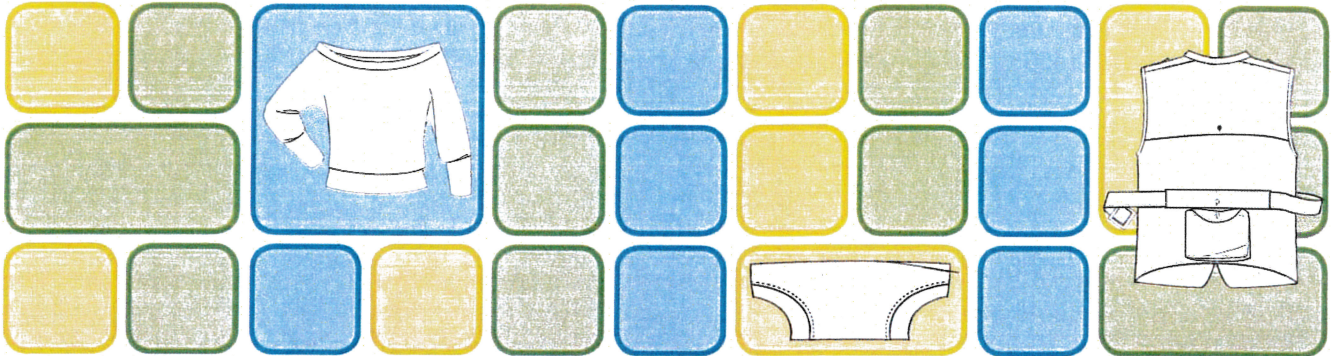

QUALITY RECOGNIZED WORLDWIDE AT VERY COMPETITIVE PRICE



FENIX

6.200 RPM

Cylinder bed
sewing machine for
tubular seams on
underwear,
knitwear, swimwear
, corsetry

 made in Italy

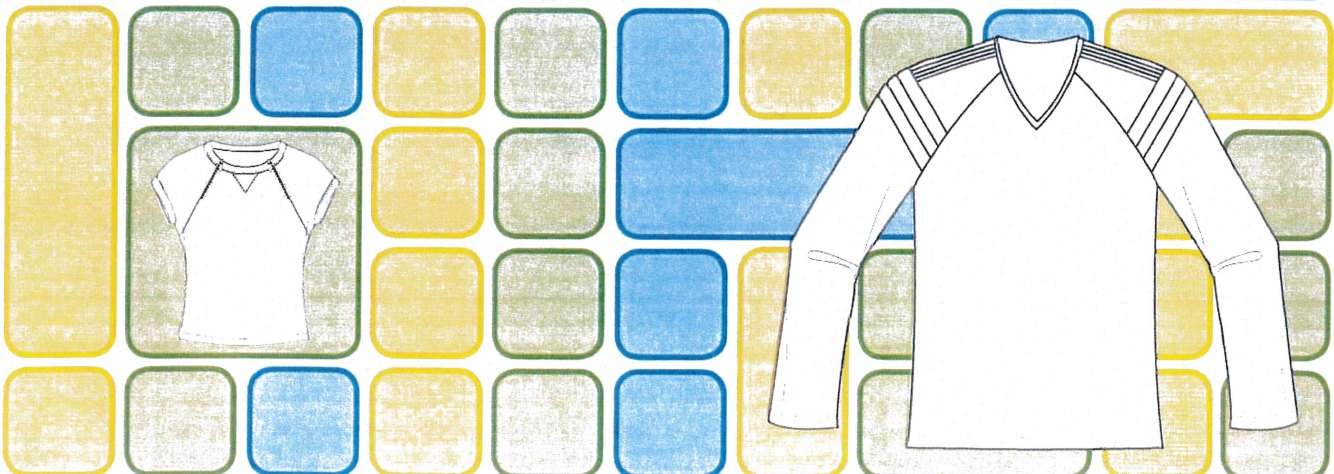

Fenix

DIVERSIFIED: a wide range for any requirements

- * F71: 2 or 3 needle cylinder bed head to get: 2 needle (406) interlock stitch without cover; 3 needle (407) interlock stitch without cover-----
- * F73: 2, 3 or 4 needle cylinder bed machine to get: 2 needle (602) interlock stitch without cover; 3 needle (605) interlock stitch with cover; 4 needle (607) interlock stitch with cover-----
- * F74: 1 needle cylinder bed machine to get (401) double chainstitch-----



PERFORMING: the best of the range

- * Speed (up to 6.200 stitches/minute)-----
- * High efficiency of feeding system-----
- * Wide range of special sophisticated electro-pneumatic devices-----
- * Forced lubrication pump-----

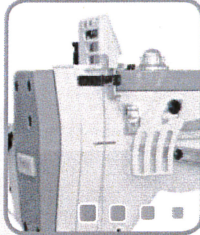

OPERATING: from words to deeds

- * Fast precise push-button stitch length adjustment-----
- * Adjustable differential feed-----
- * High quality seam with any kind of threads-----
- * Direct reading oil level-----
- * Simple threading-----

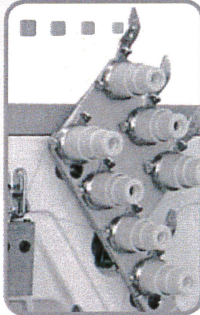

SEL-SUFFICIENT: maintenance reduced of 70%

- * New system for no-oil leakage on needle bar and presser foot bar-----
- * New external oil filter-----
- * Maximum reliability even on extreme use conditions-----
- * Easy presser foot replacement-----

ERGONOMIC AND SAFE

- * Antireflection colours-----
- * Low noise level (under CE standards)-----
- * CE labour protections-----
- * Easy and comfortable handling of the garments-----

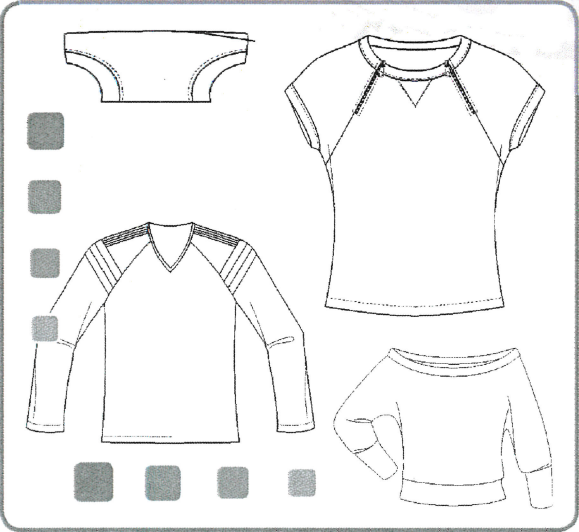

FLEXIBLE

- * Wide range of kits for different kinds of sewing operation-----
- * Adjustable needle bar stroke-----
- * Front and rear movable and independent needle guards-----
- * Quick and easy conversion-----
- * Easy to change needle holding clamp-----

Fenix Technical Files



1

Here following you will find all the FENIX Rimoldi technical files listed as per our price list and referred to the different kinds of seam and use-----

Di seguito troverete le schede tecniche relative a tutte le sottoclassi della gamma FENIX Rimoldi, ordinate, per una più facile lettura, come il listino a seconda della tipologia di utilizzo e di cucitura-----

A continuación encontrarán la ficha técnica relativa a todas las subclases de la gama FENIX Rimoldi, siguiendo el orden del listín según el tipo de utilización y de costura-----

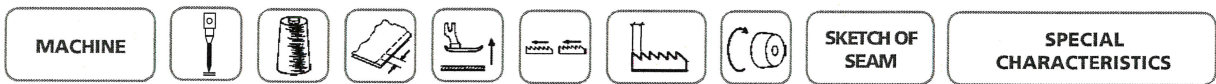

UNDERWEAR, OUTERWEAR AND SWIMWEAR

F71-66. F73-66. 3 NEEDLES. CYLINDER BED 3 NEEDLE MACHINE WITH A SHORT LEFT SIDE ARM FOR TOP STITCHING PRE-EXISTING SEAMS ON TUBULAR GARMENTS OF VERY SMALL DIAMETER. WITH OR WITHOUT COVERING STITCH, EQUIPPED WITH NEEDLE PLATE AND PRESSER FOOT WITH MOVABLE GUIDE TO GET RIGHT, MIDDLE AND LEFT TOPSTITCHING, WITH ELECTRO-PNEUMATIC THREAD CUTTER AND FOOT LIFTER. SUITABLE FOR MEDIUM WEIGHT GARMENTS-----

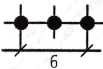
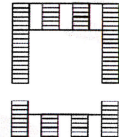
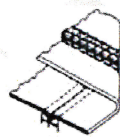
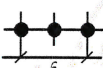
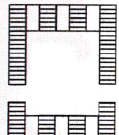
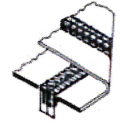
F71-06-3MD-51 558-12	Rim63	4	4	6	0,5÷1,6	1,5	6.200	407	Suitable for top-stitching operation inside the garments-----
									
F73-06-3MD-51 557-12	Rim63	4	4	6	0,5÷1,6	1,5	6.200	605	Suitable for top-stitching operation inside the garments with top cover--
									

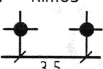
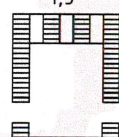
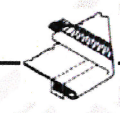
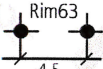
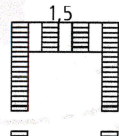

UNDERWEAR AND SWIMWEAR

F71-10. 2 NEEDLES. HEADS FOR HEMMING AND TOP STITCHING PRE-ATTACHED ELASTIC ON UNDERWEAR, SWIMSUITS, ETC-----

F71-10-2MD-50 558-12	Rim63	3	4	6	0,5÷1,6	1,5	6.200	406	Suitable for hemming and top-stitching operation-----
									
F71-10-2MD-51 558-12	Rim63	3	4	6	0,5÷1,6	1,5	6.200		Suitable for hemming and top-stitching operation-----
									

UNDERWEAR AND SWIMWEAR

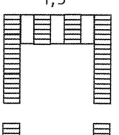
F71-10. 2 NEEDLES. HEADS FOR HEMMING AND TOP STITCHING PRE-ATTACHED ELASTIC ON UNDERWEAR, SWIMSUITS, ETC... FITTED WITH REAR PULLER-----

F71-10-2MK-01 558-42	Rim 63	3	3	6	0,5÷1,6	1,5	5.200	406	Suitable for hemming and top-stitching operation fitted with rear puller
									

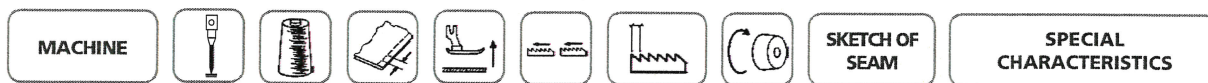

UNDERWEAR AND SWIMWEAR

F71-10. 2 NEEDLES. SHORT CYLINDER BED MACHINE FOR TOP STITCHING PRE-ATTACHED ELASTIC ON UNDERWEAR, SWIMSUITS, ETC FITTED WITH REAR PULLER-----

F71-10-2MK-50
558-42

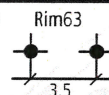

Rim63 3 4 6 0,5÷1,6 1,5 5.200 406

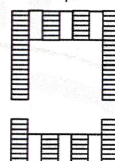

The following are available on request: presser foot code no. 311312-3-00 with off-balance shoe, in order to keep the folded edge constantly aligned with the left needle, and needle plate code no.302501-0-10-----

F71-10-2MK-51
558-42

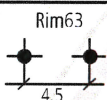

Rim63 3 4 6 0,5÷1,6 1,5 5.200 406

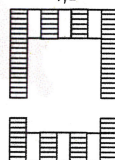

The following are available on request: foot code no. 306625-3-01 with bracket fixed on the toe in order to keep the fabric pressed and spread, and the respective needle plate code no.302512-4-12-----

UNDERWEAR AND SWIMWEAR

F71-10. 2/3 NEEDLES. FOR TOP STITCHING PRE-ATTACHED ELASTIC ON UNDERWEAR, SWIMSUITS, ETC-----

F71-10-2MD-03
558-12

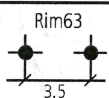

Rim63 3 3 ? 0,5÷1,6 1,5 6.200 406

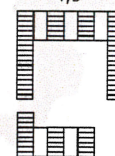

Head without covering stitch, with an adjustable guide fitted to the work surface is used for changing the hem width; a special presser foot with off-balance shoe keeps the folded edge aligned with the left needle-----

F71-10-2MD-01
558-12

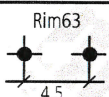

Rim63 3 3 ? 0,5÷1,6 1,5 6.200 406

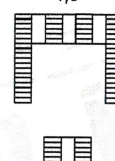

Head without feed rollers, without covering stitch, with two adjustable guides, one on the needle plate and the other on the work surface. The guide fixed to the needle plate aligns the folded edge with the left needle; the other, fitted to the work surface, is directional and is used for changing the hem width-----

F71-10-3MD-02
558-12

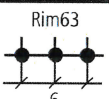

Rim63 4 3 ? 0,5÷1,6 1,5 6.200 406

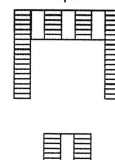

Head without feed rollers, without covering stitch, with two adjustable guides, one on the needle plate and the other on the work surface. The guide fixed to the needle plate aligns the folded edge with the left needle; the other, fitted to the work surface, is directional and is used for changing the hem width-----

UNDERWEAR AND SWIMWEAR

F73-10. 2/3 NEEDLES. FOR TOP STITCHING MINISLIPS, SWIMSUITS, AND SIMILAR ITEMS, CLOSED AT THE SIDES, MADE OF KNITWEAR AND STRETCH MATERIAL, WHICH HAVE FLAT ELASTIC ALREADY ATTACHED TO THE EDGE OF THE FABRIC WITH AN OVERLOCK MACHINE-----

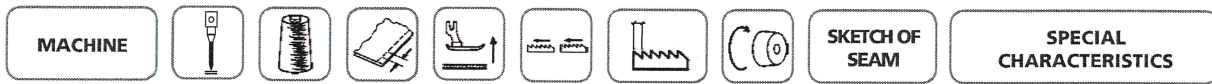

F73-10-2MD-03 557-12	Rim63 	4	4,2	6	0,5÷1,6	1,5	6.200	602		Heads without feed rollers, with adjustable guide fitted to the work surface is used for changing the hem width; a special presser foot with off-balance shoe keeps the folded edge aligned with the left needle-----
F73-10-3MD-02 557-12	Rim63 	5	4	6	0,5÷1,6	1,5	6.200	605		Heads without feed rollers, with bracket on the needle plate and directional guide on the work surface. They are fitted with two guides: one fixed on the needle plate, which is used to keep the hem edge constantly aligned with the left needle; the other adjustable, fixed on the work surface, which is used to change the hem width-----

UNDERWEAR AND SWIMWEAR

F71-10. 2 NEEDLES. FOR TOP STITCHING MINISLIPS, SWIMSUITS, AND SIMILAR ITEMS, CLOSED AT THE SIDES, MADE OF KNITWEAR AND STRETCH MATERIAL, WHICH HAVE FLAT ELASTIC ALREADY ATTACHED TO THE EDGE OF THE FABRIC WITH AN OVER-LOCK MACHINE WITH REAR PULLER-----

F71-10-2MK-05 558-42	Rim63 	3	4,2	6	0,5÷1,6	1,5	5.200	406		For pre-attached elastic hemming and topstitching operation. Equipped with fixed guide fitted on needle plate for a perfect alignment of the edge----
--------------------------------	-----------	---	-----	---	---------	-----	-------	-----	--	---

VARIOUS ARTICLES

F73-10. 2/3 NEEDLES. FOR TOP STITCHING PRE-ATTACHED ELASTICS-----

F73-10-2MK-03 557-42	Rim 63 	4	4,2	6	0,5:1,6	1,5	5.200	406		Head with covering stitch, with adjustable guide fitted on the work surface and off-balanced presser foot. An adjustable guide fitted to the work surface is used for changing the hem width; a special presser foot with off-balance shoe keeps the folded edge aligned with the left needle----
F73-10-3MK-02 557-42	Rim63 	5	3,5	6	0,5÷1,6	1,5	5.200	406		Head fitted with rear geared feed rollers, which cooperate in feeding the fabric thus making sure the semi-finished garment flows perfectly regularly and causing the fabric to gather; their movement is intermittent and their speed, adjustable. With bracket on the needle plate and directional guide on the work surface-----

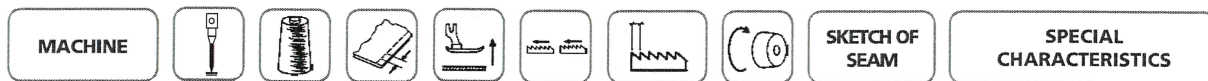





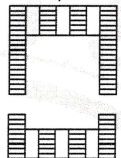
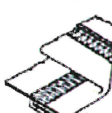

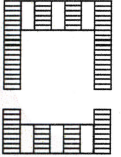

UNDERWEAR AND SWIMSUIT

73T-10. 2/3 NEEDLES. FLAT BED MACHINE EQUIPPED WITH TOP FEED DOG ON THE FOOT FOR CROTCH SEAMS-----

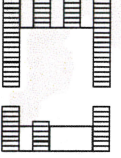
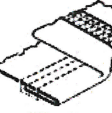
73T-10-3MD-02 557-12	Rim63	5	4,2	6	A 1÷6 B 0,5÷1,6	1,5	5.500	605	Top feeding machine with covering stitch suitable for hemming critical fabrics and for topstitching pre-attached elastics-----
									

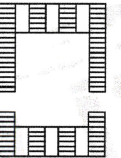
OUTERWEAR AND UNDERWEAR

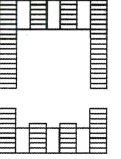

F71-10. F73-10. 2/3 NEEDLES. HEAD WITHOUT (F71) OR WITH (F73) COVERING STITCH FOR CARRYING OUT HEMMING OPERATIONS ON LIGHT AND MEDIUM WEIGHT UNDERWEAR AND KNIT OUTERWEAR IN TUBES OR CLOSED AT THE SIDES--

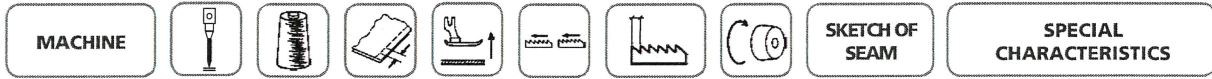
F71-10-2MD-04 558-12 (without cover stitch)	Rim 63	3	3	6	0,5÷1,6	1,5	6.200	406	Heads without feed rollers, with bracket on the needle plate and directional guide on the work surface. They are fitted with two guides: one fixed on the needle plate, which is used to keep the hem edge constantly aligned with the left needle; the other, adjustable, fixed on the work surface, which is used to change the hem width-----
									
F71-10-3MD-01 558-12 (without cover stitch)	Rim63	4	3,5	6	0,5÷1,6	1,5	6.200	406	
									
F73-10-2MD-04 557-12 (with cover stitch)	Rim63	4	3	6	0,5÷1,6	1,5	6.200	602	
									
F73-10-3MD-01 557-12 (with cover stitch)	Rim63	5	3,5	6	0,5÷1,6	1,5	6.200	602	
									





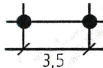
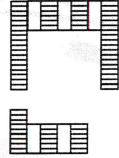

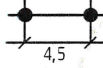
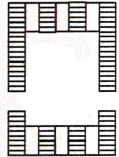
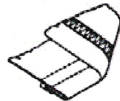
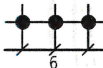
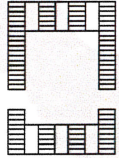
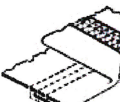
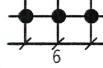
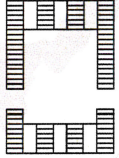
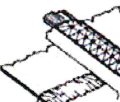
OUTERWEAR AND UNDERWEAR

F71-10. F73-10. 2/3 NEEDLES. HEADS WITHOUT (F71) OR WITH (F73) COVERING STITCH FOR HEMMING OPERATIONS ON TUBULAR ARTICLES MADE OF HEAVY MATERIALS AND STRETCH FABRICS, SUCH AS FLEECE WEAR, TRAINING SUITS, BODY BELTS AND GIRDLES-----

F71-10-2MK-03 558-42	Rim63 	3	3	6	0,5÷1,6	1,5	5.200	406	 	Heads fitted with rear geared feed rollers (the upper roller is motorized, and the lower, idle) which cooperate in feeding the fabric thus making sure the semi-finished garments flows perfectly regularly; their movement is intermittent and their speed, adjustable. Equipped with bracket on the needle plate and directional guide on the work surface-----
F71-10-2MK-04 558-42	Rim63 	3	3	6	0,5÷1,6	1,5	5.200	406	 	
F71-10-3MK-01 558-42	Rim63 	4	3,5	6	0,5÷1,6	1,5	5.200	406	 	
F73-10-3MK-04 557-42 (with cover stitch)	Rim63 	5	3	6	0,5÷1,6	1,5	5.200	605	 	

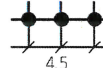
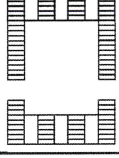
KNITWEAR

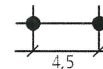
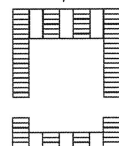
71T-10. 73T-10. 3 NEEDLES. FOR CARRYING OUT HEMMING OPERATIONS ON LIGHT AND MEDIUM WEIGHT UNDERWEAR AND KNIT OUTERWEAR IN TUBES OR CLOSED AT THE SIDES-----

71T-10-3MD-01 558-12	Rim63 	4	3,2	6	0,5÷1,6	1,5	5.500	406	 	The top-feed ensures a relaxed seam without screwing and twisting. The machines are fitted with two adjustable guides: one on the needle plate and the other on the work surface. The guide fixed to the needle plate aligns the folded edge with the left needle; the adjustable guide fitted to the work surface is used to change the hem width-----
73T-10-2MD-04 587-12	Rim63 	4	3,2	6	0,5÷1,6	1,5	5.500	605	 	

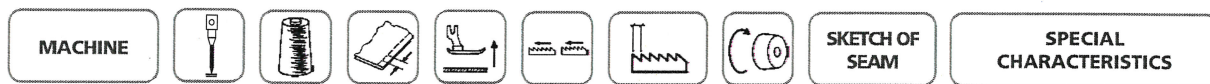

MACHINE	Needle	Stitch	Presser Foot	Max. Width	Max. Length	Max. Thickness	Max. Speed	Max. Tension	SKETCH OF SEAM	SPECIAL CHARACTERISTICS
73T-10-3MD-01 587-12	Rim63	5	3,2	6	0,5÷1,6	1,5	5.500	605		The top-feed ensures a relaxed seam without screwing and twisting. The machines are fitted with two adjustable guides: one on the needle plate and the other on the work surface. The guide fixed to the needle plate aligns the folded edge with the left needle; the adjustable guide fitted to the work surface is used to change the hem width-----

UNDERWEAR AND OUTERWEAR

F71-10. F73-10. 2/3 NEEDLES. FOR CARRYING OUT HEMMING OPERATIONS ON LIGHT AND MEDIUM WEIGHT UNDERWEAR AND KNIT OUTERWEAR IN TUBES OR CLOSED AT THE SIDES FITTED WITH LEFT SIDE TRIMMING KNIVES-----

F71-10-2MR-01 558-12 (without covering stitch)	Rim63	3	4,2	6	0,5÷1,6	1,5	5.500	406		Heads, without covering stitch, provided with left-hand trimming knife removing excessive fabric, thus ensuring a high quality seam; also fitted with a hemming guide with central blade; disengageable with knee press control, allowing a continuous hem to be sewn without stopping and starting-----
F71-10-3MR-02 558-12 (without covering stitch)	Rim63	3	4,2	6	0,5÷1,6	1,5	5.500	407		Heads, without covering stitch, provided with left-hand trimming knife removing excessive fabric, thus ensuring a high quality seam; also fitted with a hemming guide with central blade; disengageable with knee press control, allowing a continuous hem to be sewn without stopping and starting-----
F73-10-2MR-01 557-12 (with covering stitch)	Rim63	4	4,2	6	0,5÷1,6	1,5	5.500	602		Heads, with covering stitch, provided with left-hand trimming knife removing excessive fabric, thus ensuring a high quality seam; also fitted with a hemming guide with central blade; disengageable with knee press control, allowing a continuous hem to be sewn without stopping and starting-----
F73-10-3MR-02 557-12 (with covering stitch)	Rim63	5	4,	6	0,5÷1,6	1,5	5.500	605		Heads, with covering stitch, provided with left-hand trimming knife removing excessive fabric, thus ensuring a high quality seam; also fitted with a hemming guide with central blade; disengageable with knee press control, allowing a continuous hem to be sewn without stopping and starting-----

VARIOUS ARTICLES

F71-11. 2/3 NEEDLES. HEADS FOR HEMMING AND INSERTING ELASTIC CLOSED INTO RINGS, WHICH ARE FREE TO MOVE INSIDE THE HEM, ON LADIES' PANTIES, MEN'S BRIEFS, PYJAMA TROUSERS AND SIMILAR TUBULAR GARMENTS-----

F71-11-2MD-01 558-12	Rim63	3	3,2	6	0,5÷1,6	1,5	6.200	406		Equipped with hemming adjustable guide to get an easy hem with ring elastic insertion-----
---------------------------------------	-------	---	-----	---	---------	-----	-------	-----	--	--

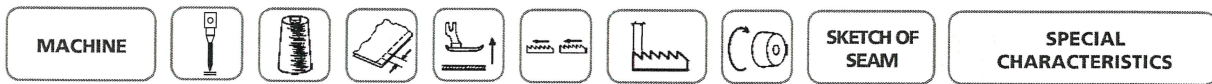

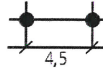
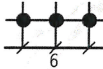
F71-11-2MD-02 558-12	Rim63 	3	3,2	6	0,5÷1,6	1,5	6.200	406	As above-----
F71-11-3MD-01 558-12	Rim63 	4	3,2	6	0,5÷1,6	1,5	6.200	407	As above but 3 needles-----

VARIOUS ARTICLES

F71-11. F73-11.2 NEEDLES. HEAD WITH REAR PULLER FOR HEMMING AND INSERTING ELASTIC CLOSED INTO RINGS, WHICH ARE FREE TO MOVE INSIDE THE HEM, ON LADIES' PANTIES, MENS' BRIEFS, PYJAMA TROUSERS AND SIMILAR TUBULAR GARMENTS

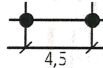
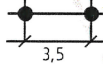
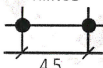
F71-11-2MK-04 558-42	Rim63 	3	3,2	6	0,5÷1,6	1,5	5.200	406	This head, without covering stitch, is fitted with rear geared feed rollers (the upper roller is motorized, and the lower, idle), which cooperate in feeding the fabric thus making sure the semi-finished garment flows perfectly regularly and causing the fabric to gather. The feed rollers move intermittently and their speed is adjustable-----
F73-11-2MK-01 557-42	Rim63 	4	4,2	6	0,5÷1,6		5.200	406	Head with covering stitch-----
F73-11-2MK-04 557-42	Rim63 	4	3	6	0,5÷1,6		5.200	602	Head with covering stitch-----

VARIOUS ARTICLES

F71-16 3 NEEDLES. FOR ATTACHING A RING OF U-FOLDED ELASTIC BAND TO THE WAISTS OF BRIEFS, PANTIES AND SIMILAR ARTICLES ALREADY CLOSED AT THE SIDES-----

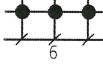
F71-16-3MK-01 558-42	Rim 63 	4	3,2	6	0,5÷1,6		5.200	407	Head, without covering stitch, fitted with rear geared feed rollers (the upper roller is motorized and the lower, idle), which cooperate in feeding the fabric thus making sure the semi-finished garment flows perfectly regularly; their movement is intermittent and their speed, adjustable. The heads also have adjustable positioning rollers for guiding and tensioning the garment during the sewing. A special guide, which is opened using a knee press control, makes threading in the band and completing the last part of the sewing-----
--------------------------------	---	---	-----	---	---------	--	-------	-----	--

CATALOGUE
Fenix
MADE IN ITALY

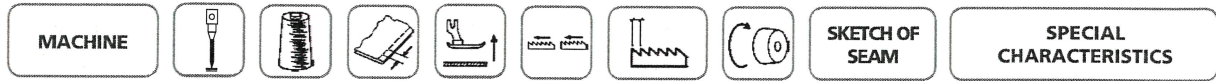

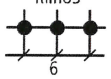
F73-16-3MK-02 557-42	Rim63 	5	2,8	6	0,5÷1,6	1,5	5.200	605	Head with covering stitch-----
---------------------------------------	--	---	-----	---	---------	-----	-------	-----	--------------------------------

VARIOUS ARTICLES

F71-34. 3 NEEDLES. HEADS WITH TRIMMING KNIVES FOR ATTACHING ELASTICS, PREVIOUSLY CLOSED INTO RINGS, TO THE WAISTS OF BRIEFS, PYJAMAS, TRAINING SUITS AND SIMILAR GARMENTS ALREADY CLOSED AT THE SIDES-----

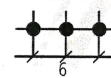
F71-34-3MR-02 558-42	Rim63 	4	2,8	6	0,5÷1,6	1,5	5.500	?	They are fitted with free tensioning rollers for guiding and tensioning the elastic. They are fitted with trimming knives placed in front of the needles, which are pneumatically disengageable using a knee press control; they trim the edge of the fabric, in order to achieve a clean frayless seam on the underside-----
---------------------------------------	--	---	-----	---	---------	-----	-------	---	---

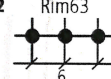
F73-34-3MR-02 557-12	Rim63 	5	2,8	6	0,5÷1,6		5.500	?
---------------------------------------	---	---	-----	---	---------	--	-------	---

SPECIAL SEAMS

F73-66. 3 NEEDLES. ?

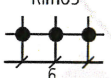
F73-66-3MD-05 557-12	Rim63 	5	2,8	6	0,5÷1,6	1,5	5.500	605	Suitable for assembling, hemming and topstitching operations with ornamental seams on knitwear, underwear and swimsuits. It can be used for the application of cuffs, gussets, tapes on underwear garments such as slips, corsetry etc--
---------------------------------------	--	---	-----	---	---------	-----	-------	-----	--

KNITWEAR



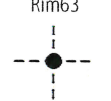

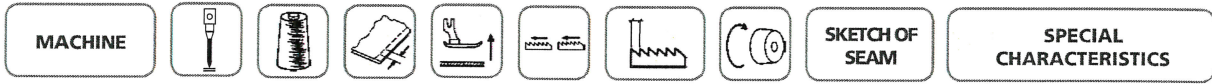
F74-16. 1 NEEDLE. CYLINDRICAL BED 1 NEEDLE DOUBLE CHAINSTITCH MACHINE FOR KNITTED COLLARETTE ATTACHING ON KNITWEAR-----

F74-16-1MD-06 558-12	Rim63 	2	2,8	6	0,5÷1,6	1,5	5.500	401	To attach ring selvedged knitted straps on knitwear garments. The head is doing a stitch similar to the linking but the productivity is higher. The cylinder bed shape of the head assure an easy operation for the worker. The special guide is turning to facilitate the insertion of the collarette and it is adjustable depending on the width of the strap. The head is equipped with special sewing parts and differential feeding-
---------------------------------------	--	---	-----	---	---------	-----	-------	-----	---



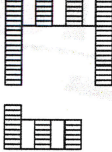

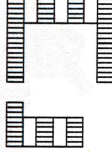



UNDERWEAR AND SWIMWEAR

177-10. 1 NEEDLE. FOR TOP STITCHING OF ELASTICS ATTACHED TO THE LEG OPENINGS AND WAISTS OF MINISLIPS AND SWIMSUITS AND SIMILAR GARMENT-----

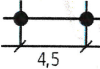
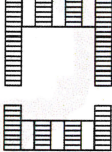
177-10-1MD-01 538-70	Rim67	2	3,2	6	0,5÷1,6	1,5	5.200	404	One-needle zig-zag double locke chainstitch flat-bed machine for top stitching the leg openings and waists of minislips and swimsuits made of stretch materials closed at the sides with elastic previously attached to the edge of the fabric using an over-lock machine-----
									
177-10-1MD-01 564-70	Rim67	2	3,2	6	0,5÷1,6	1,5	5.200	404	One-needle zig-zag double locke chainstitch flat-bed machine for top stitching the leg openings and waists of minislips and swimsuits made of stretch materials closed at the sides with elastic previously attached to the edge of the fabric using an over-lock machine-----
									

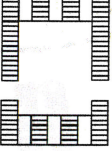

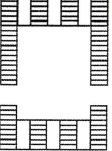
KNITWEAR

PL71/73. 2/3 NEEDLES. BOTTOM HEMMING OF TUBULAR GARMENTS EQUIPPED WITH TRIMMING KNIVES ON THE LEFT OF THE NEEDLE FOR A PERFECT ALIGNEMENT OF THE EDGE-----

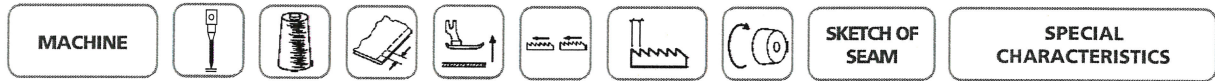



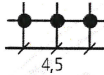





PL71-F255-B6	Rim	3	3,2	6	0,5÷1,6	1,5	5.200	406	Workstation composed of Fenix cylindrical bed machine with ornamental stitch without covering, equipped with left trimming knives, disengageable looper, right tread trimmer, lighting cover, pneumatic waste vacuuming device and hemming guide on movable slide-----
									
PL71-F255-B7	Rim	4	3,2	6	0,5÷1,6	1,5	5.200	406	Same as above-----
									
PL73-F255-B7	Rim	5	3,2	6	0,5÷1,6	1,5	5.200	406	Same as above but with cover stitch-----
									





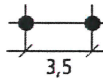

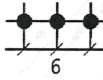
KNITWEAR
PL71X/73X. PL73TX. 2/3 NEEDLES. BOTTOM HEMMING OF RING FABRIC EQUIPPED WITH AUTOMATIC GUIDE-----



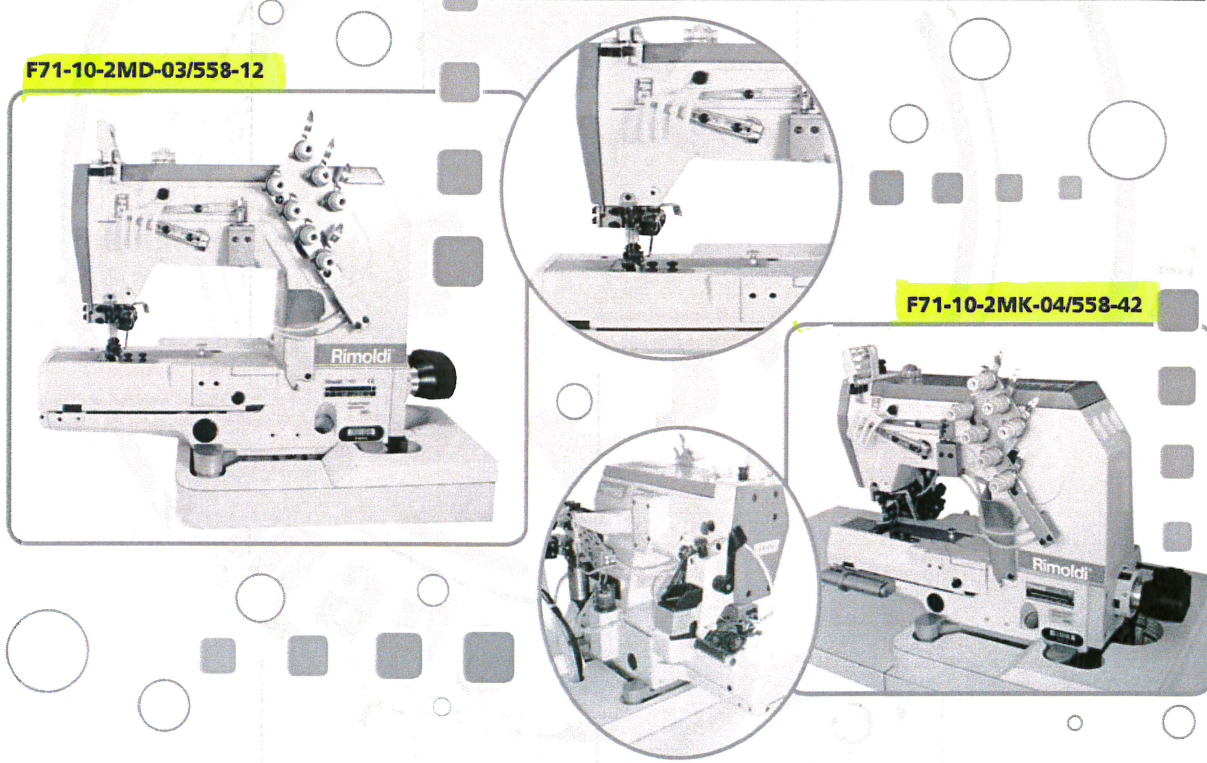

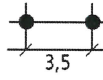

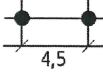



PL71X-10-3MD-45TF	Rim63 	4	3,2	6	0,6÷1,6	1,5	5.500	407	Workstation for closed ring hems with adjustable hem from 15 to 24,5 mm. Equipped with special electro-pneumatic hemmer to get high quality seams with high productivity level. The automatic opening and closing system of the guide controlled by photocell and the pneumatic loading of the hem inside it, let the operator work very easily. The upper feeding system is also providing a perfect hem. Equipped with thread trimmer and electropneumatic footlifter-----
PL73X-10-3MD-45TF	Rim63 	5	9÷14	5	0,5÷1,6	1,5	5.500	605	As above with top covering stitch----
PL73TX-10-3MD-45TF	Rim63 	5	9÷14	5	0,5÷1,6		5.500		Complete unit for closed ring hems with adjustable hem width from 15 to 24,5 mm. Equipped with special electro-pneumatic hemmer to get high quality seams with high productivity level. The automatic opening and closing system of the guide controlled by photocell and the pneumatic loading of the hem inside it, let the operator work very easily. The upper feeding system is also providing a perfect hem. Equipped with thread trimmer and electropneumatic footlifter-----

The best of Fenix range

MACHINE								SKETCH OF SEAM	SPECIAL CHARACTERISTICS
F71-10-2MD-03 558-12	Rim63 	3	6÷16	6	0,5÷1,6	1,5	6.000	406 	Cylinder bed 2 needle machine equipped with an adjustable guide to obtain different size of hems; a special compensating foot keeps the edge aligned with the left needle. Suitable for topstitching a pre-closed elastic and or hemming small size closed garments on underwear, bath suits etc. Equipped with electro-pneumatic thread cutter and foot lifter-----
F73-10-3MD-02 557-12	Rim63A 	5	6÷16	6	0,5÷1,6		6.200	605 	Cylinder bed 3 needle covering stitch machine equipped with an adjustable guide to obtain different sizes of hem; a special compensating foot keeps the edge aligned with the left needle. Suitable for topstitching a pre-closed elastic and or hemming small size closed garments on underwear, bath suits etc. Equipped with electro-pneumatic thread cutter and foot lifter-----

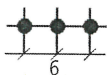

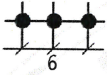
F73-10-2MD-03 557-12	Rim63A 	4	6÷16	6	0,5÷1,6		6.200	602 	Cylinder bed 2 needle covering stitch machine equipped with an adjustable guide to obtain different sizes of hem; a special compensating foot keeps the edge aligned with the left needle. Suitable for topstitching a pre-closed elastic and or hemming small size closed garments on underwear, bath suits etc. Equipped with electro-pneumatic thread cutter and foot lifter-----
F71-10-2MK-04 558-42	Rim63A 	3	6÷16	6	0,5÷1,6		5.500	406 	Cylinder bed 2 needle covering stitch machine equipped with an adjustable guide to obtain different sizes of hem and with a puller for better feeding. Suitable for topstitching operations on tubular garments on underwear, bath suits and sportswear. Equipped with electro-pneumatic thread cutter and foot lifter-----

MACHINE								SKETCH OF SEAM	SPECIAL CHARACTERISTICS
F73-10-3MR-02 557-12	Rim63 	5	9÷14	5	0,5÷1,6	1,5	5.500		Cylinder bed 3 needle, covering stitch machine with left trimming knife for hemming operation on tubular underwear and knitwear. Equipped with an adjustable guide to obtain different sizes of hem and with electro-pneumatic thread cutter and foot lifter----
F71-16-3MK-01 558-42	Rim63 	4	9÷14	5	0,5÷1,6	1,5	5.200		407  Equipped with a fast opening guide to obtain different sizes of hem, puller for a better feeding of the fabric and with electro-pneumatic thread cutter and foot lifter-----

F73-10-3MR-02/557-12

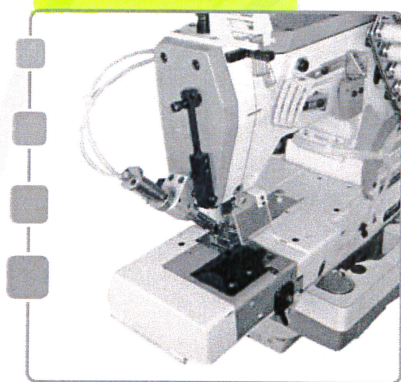

PL73T- X10-3MD-45-TF

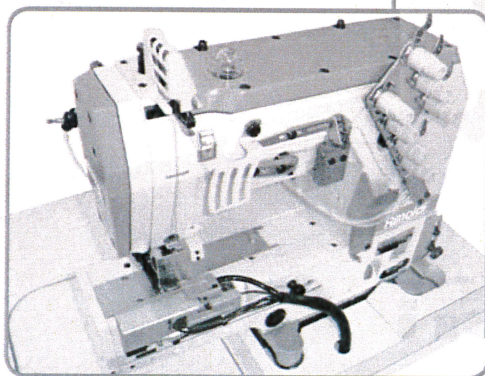
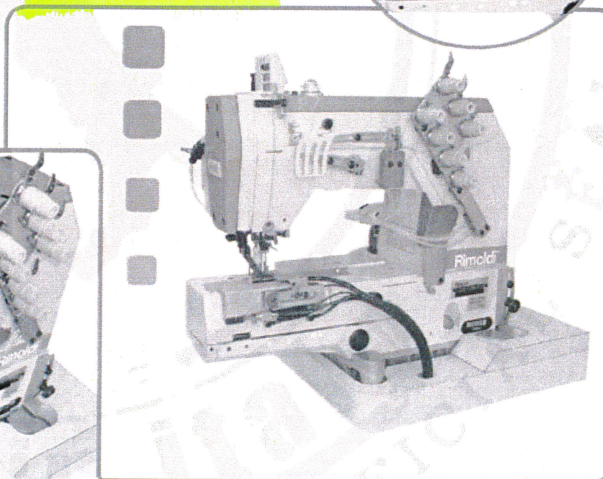

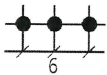
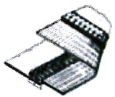
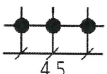
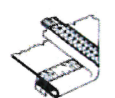
F73-34-3MR-02 557-42	Rim63 	5	9÷18	5	0,5÷1,6	1,5	5.500		Cylinder bed 3 needle covering stitch machine for attaching a pre-closed elastic ring to waist of briefs, pyjamas and similar garments. Equipped with free tensioning rollers for guiding and tensioning the elastic and disengageable trimming knife and with electro-pneumatic thread cutter and foot lifter-----
PL73T- X10-3MD 45-TF	Rim63 	5	9÷14	5	0,5÷1,6	1,5	5.500		Complete unit for closed ring hems with adjustable hem width from 15 to 24,5 mm. Equipped with special electro-pneumatic hemmer to get high quality seams with high productivity level. The automatic opening and closing system of the guide controlled by photocell and the pneumatic loading of the hem inside it, let the operator work very easily. The upper feeding system is also providing a perfect hem. Equipped with thread trimmer and electropneumatic footlifter-----

Flexsystem and Flexibility of Fenix

The garments market is continuously evolving and for this reason CF Rimoldi decided to support and to promote FLEXSYSTEM. Thanks to interchangeable kits the machine has an excellent flexibility to meet with the always different market requirements-----

1 Rear puller kit-----

In order to adapt the machine to the different requirements of fabric -----

2_Cover kit-----

In order to obtain 2,3 and 4 needle interlock stitch with upper cover-----



3_Disengageable/ fixed trimming knife kit-----

In order to trim the edge of the material when attaching elastic-----

6_Upper thread cutting device kit-----

In order to cut the cover thread----

4_Mechanical upper metering roller kit-----

In order to feed elastic from above in a regular and continuous way-----

5_Lower thread cutting device kit-----

In order to cut the needle and looper threads-----

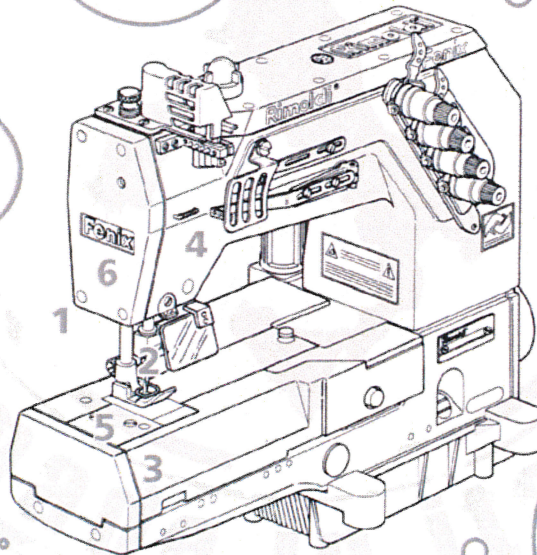

Special Devices for Fenix

127_Pneumatic footlifter-----





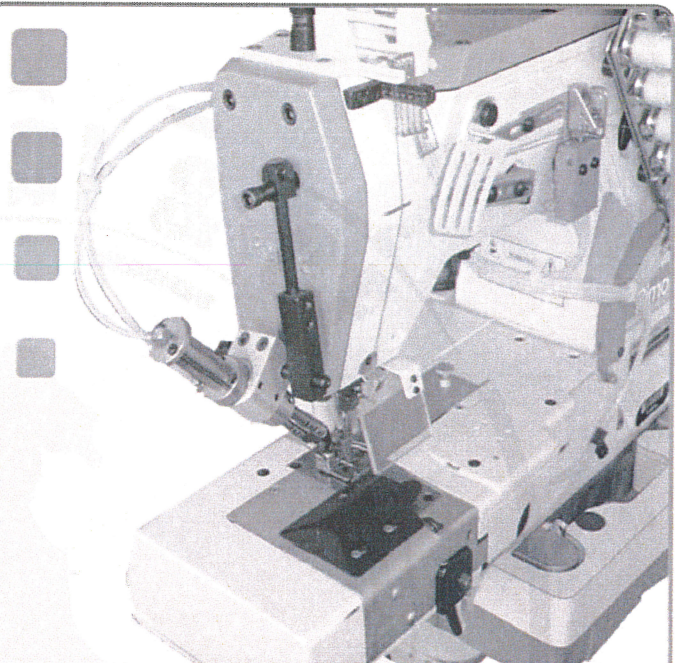
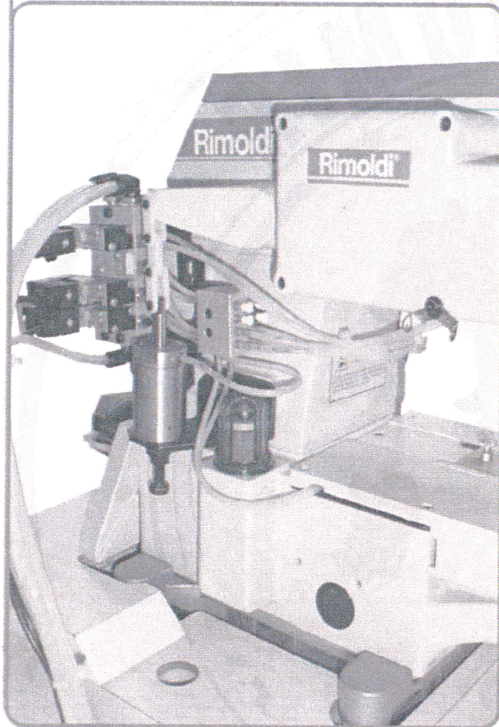

269_Waste suction device-----

256_Stitch condensing device
(it can be operated while the
machine is running)-----



557-558_ Needle, lower looper and cover looper
thread cutting devices-----

1

 NEEDLE SYSTEM NO. OF NEEDLES GAUGE (mm)	 NUMBER OF THREAD	 MAX STITCH LENGTH (stitch/inch)	 PRESSER FOOT LIFT
 DIFFERENTIAL FEED VARIA- TION FEED	 FEED DOG PITCH	 REVOLUTIONS OF MINUTE	

