

Rimoldi

CATALOGO PEZZI DI RICAMBIO
SPARE PARTS CATALOGUE
CATALOGUE RECHANGES
ERSATZTEILELISTE

APPARECCHIATURE
ATTACHMENTS
DISPOSITIFS
VORRICHTUNGEN

135-81 136-81
137-81

n. 237

652090220

UFFICIO CATALOGHI 7/80

Il presente Catalogo Pezzi di Ricambio è costituito dai particolari componenti l'apparecchiatura e dalle varianti relative alla testa sulla quale la stessa è applicata.

Nella consultazione del Catalogo tenere presente che:

1. Tutti i particolari non fornibili sciolti non vengono richiamati singolarmente, ma soltanto illustrati nel gruppo di appartenenza.
2. I riferimenti delle figure dei particolari che compongono il gruppo sono di norma raggruppati in una parentesi. In alcuni casi però, dove non è possibile il raggruppamento, i numeri che nelle tavole illustrative richiamano i singoli pezzi sono affiancati dallo stesso segno particolare, con cui è indicato l'intero gruppo.
3. I particolari definiti come "PEZZI ANNULLATI" si intendono quelli non montati sulla testa, o sostituiti dai particolari specifici componenti l'apparecchiatura stessa.
Nel caso di un gruppo annullato, viene indicato soltanto il simbolo del gruppo, ma devono intendersi annullati anche tutti i particolari componenti il gruppo stesso.
4. Nelle tavole dove i particolari raffigurati non sono richiamati, si intendono appartenenti alla testa e pertanto vanno ricercati sul Catalogo della testa interessata.
I particolari raffigurati e richiamati (es.: organi di cucitura), annullano e sostituiscono i corrispondenti citati sul Catalogo della testa.

AVVERTENZA

Nella richiesta di parti di ricambio, citare sempre il simbolo del particolare e la denominazione ufficiale usata nel catalogo.

This parts catalogue includes the parts making up the device and variants relative to the machine on which it is fitted.

When you consult the catalogue will you please note that:

1. all parts which cannot be supplied by themselves are not indicated alone, but shown together with the group to which they belong;
2. the references of the pictures of the parts making up the group are usually put in brackets.
In some cases, however, when their grouping is not possible, the numbers of the various parts in the tables are marked with the same particular sign with which the whole group is indicated.
3. The parts described as "CANCELLED PARTS" are those not fitted on the machine, or replaced by specific components of the device itself.
When an assembly has been annulled only the assembly symbol is specified, but all the parts forming the assembly must also be considered annulled.
4. In the tables where parts illustrated are not listed, said parts belong to the machine and therefore must be sought in the parts catalogue for the machine in question. The parts illustrated and listed (e.g. sewing parts) cancel and replace the corresponding parts in the machine catalogue.

ATTENTION

When ordering spare parts always state the serial number of the machine, the symbol of the part in question and the description given in the catalogue.

Ce catalogue de pièces détachées concerne les pièces composant le dispositif ainsi que les variantes relatives à la tête sur laquelle le dispositif est appliqué.

Lorsque l'on consulte le catalogue, se souvenir que:

1. Toutes les pièces qui ne sont pas fournies séparément mais qui font partie d'un groupe, ne sont pas indiquées séparément.
2. Les symboles des pièces qui forment un groupe sont regroupés entre parenthèses. Cependant, lorsque ceci n'a pas été possible, les symboles, qui dans les tables d'illustration correspondent aux pièces, sont suivis du même signe particulier qui indique le groupe tout entier.
3. Les pièces indiquées comme "PIECES ANNULEES" sont celles non montées sur la tête ou remplacées par des pièces spécifiques composant le dispositif.
Dans le cas de l'annulation d'un groupe, nous indiquons seulement le symbole du groupe, mais toutes les pièces qui forment ce groupe sont annulées.
4. Dans les tableaux où les pièces illustrées ne sont pas citées, il s'agit de pièces appartenant à la tête; pour ces pièces, il faut consulter le catalogue de la tête en question.
Les pièces illustrées et citées (par exemple: organes de couture) annulent et remplacent les pièces correspondantes citées sur le catalogue de la tête.

ATTENTION

Dans la commande de pièces détachées, indiquer toujours le numéro de la machine, le symbole de la pièce et la dénomination officielle mentionnée sur le catalogue.

APPARECCHIATURA ATTACHMENT DISPOSITIF VORRICHTUNG

135-81

PER TESTE	527-00-1CD-01	527-00-1CD-39	527-10-1CD-02
FOR HEADS	527-00-1CD-02	527-00-1MD-23	527-10-1CD-06
POUR TETES	527-00-1CD-05	527-00-2CD-12	527-22-1CD-02
FUER OBERTEILE	527-00-1CD-06	527-00-2CD-13	527-22-1CD-03
	527-00-1CD-07	527-00-2CD-38	527-28-1CD-02
	527-00-1CD-09	527-00-2CD-41	527-28-1CD-07
	527-00-1CD-10	527-00-2CD-44	527-28-1CD-09
	527-00-1CD-20	527-00-2CD-47	527-28-1CD-12
	527-00-1CD-25	527-00-2CS-02	527-28-1CU-04
	527-00-1CD-29	527-00-2MD-20	527-28-1CU-06
	527-00-1CD-31	527-00-2MD-36	

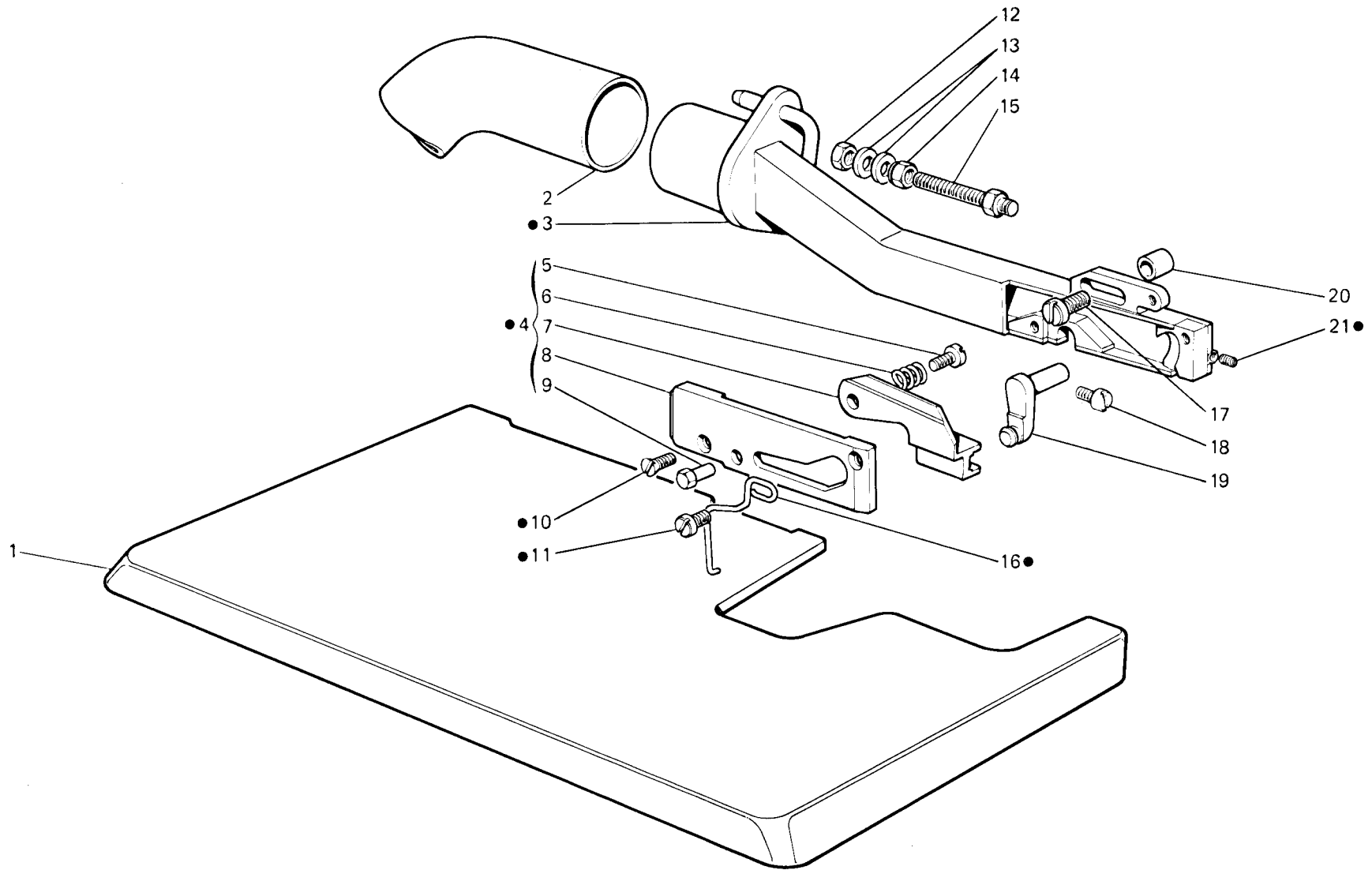

Fig. N. Abb. N.	Part. N. Bestell N. Piece N. Pieza N.	Qt. Anzahl	DESCRIZIONE	DESCRIPTION	DESCRIPTION	BENENNUNG	DESCRIPCION
●	923989-4-00	1	aspira catenella completa	chain suction assembly	aspiration chaînette complète		
1	926323-2-01	1	piano di lavoro completo	working plate assembly	plan de travail complet		
2	923806-0-00	1	tubo	pipe	tube		
3	923978-2-00	1	tubo aspirazione	pipe	tube		
4	926755-4-01	1	gruppo coltelli	knives assembly	groupe couteaux		
5	926758-0-00	1	vite	screw	vis		
6	923918-0-01	1	molla	spring	ressort		
7	926754-2-01	1	coltello mobile	movable knife	couteau mobile		
8	926753-2-01	1	coltello fisso	immovable knife	couteau fixe		
9	923919-0-01	1	perno	pin	pivot		
10	744530-0-00	2	vite	screw	vis		
11	721410-0-00	1	vite	screw	vis		
12	746021-2-00	1	dado	nut	écrou		
13	704310-2-00	2	rondella	washer	rondelle		
14	923943-0-00	1	dado autobloccante	nut	écrou		
15	923942-0-00	1	perno filettato	pin	pivot		
16	923936-0-01	1	molla limitazione	spring	ressort		
17	741974-2-00	1	vite	screw	vis		
18	741931-0-00	1	vite	screw	vis		
19	923985-0-00	1	azionatore	actuator	activateur		
20	923976-0-00	1	distanziale	spacer	entretoise		
21	745001-0-00	1	vite	screw	vis		

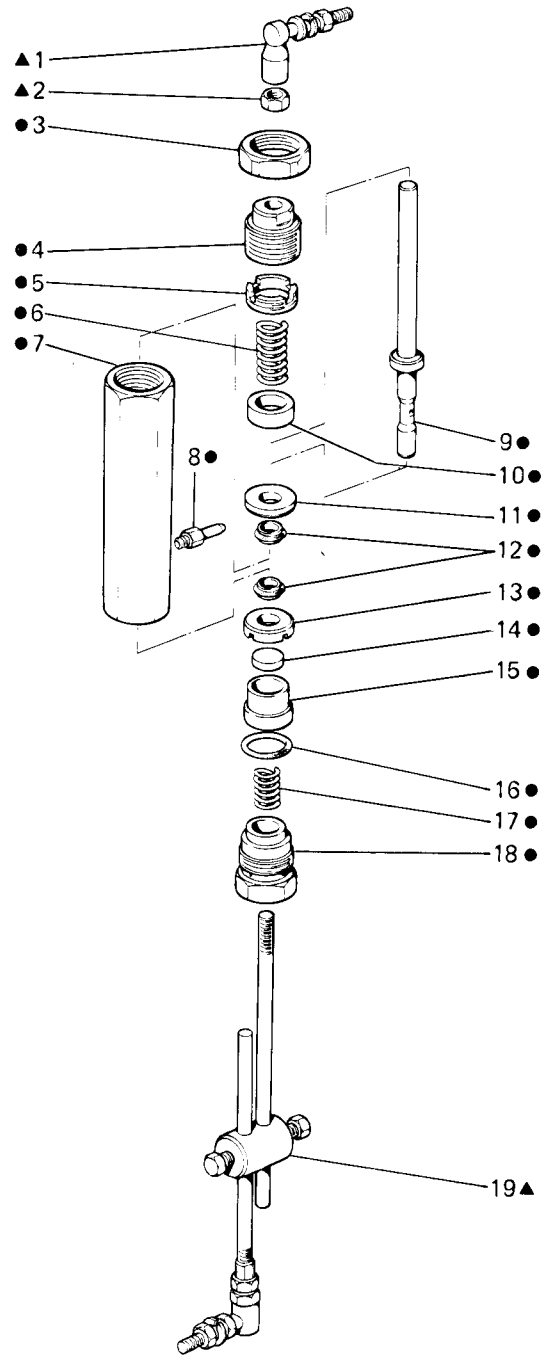

Fig. N. Abb. N.	Part. N. Piec. N. Bestell N. Pieza N.	Qt. Anzahl	DESCRIZIONE	DESCRIPTION	DESCRIPTION	BENENNUNG	DESCRIPCION
▲●	923815-5-00	1	tirante completo	tie-rod assembly	tirant complet		
●	923816-4-00	1	valvoia completa	valve assembly	soupape complète		
1	900942-0-00	1	snodo	knuckle	axe		
2	746203-4-00	1	dado	nut	écrou		
3	924796-0-10	1	dado	nut	écrou		
4	924790-0-10	1	tappo	plug	bouchon		
5	924800-0-11	1	ghiera	ring nut	collier		
6	203909-0-11	1	molla	spring	ressort		
7	923819-0-00	1	cilindro	cylinder	cylindre		
8	924797-0-10	2	attacco	pipe union	raccord		
9	923818-0-00	1	pistone	piston	piston		
10	923825-0-00	1	distanziale	spacer	entretoise		
11	923822-0-00	1	rondella	washer	rondelle		
12	923828-4-00	2	anello di tenuta	retainer ring	bague d'étanchéité		
13	923823-0-00	1	rondella	washer	rondelle		
14	923821-0-00	1	pastiglia	plug	bouchon		
15	923820-0-00	1	distanziale	spacer	entretoise		
16	701017-0-00	1	anello di tenuta	retainer ring	bague d'étanchéité		
17	923826-0-00	1	molla	spring	ressort		
18	923824-0-00	1	tappo	plug	bouchon		
19	923812-0-00	1	tirante	tie-rod	tirant		

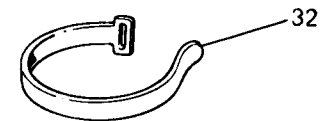
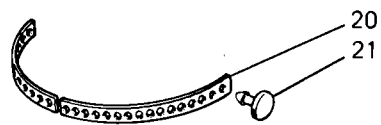
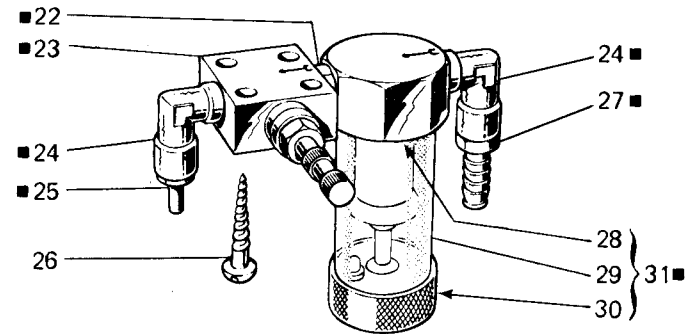
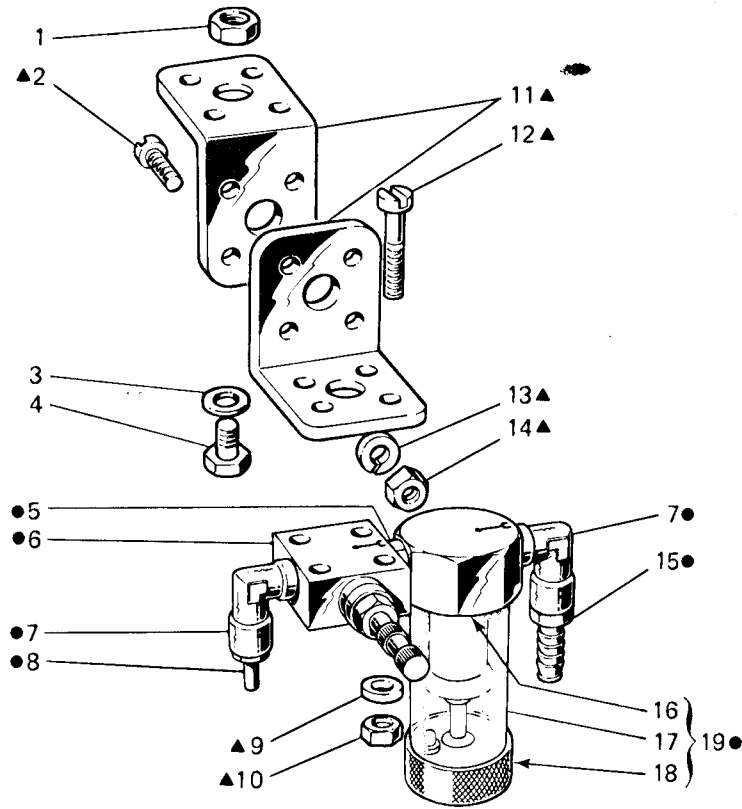

Fig. N. Abb. N.	Part. N. Bestell N. Piece N. Pieza N.	Qt. Anzahl	DESCRIZIONE	DESCRIPTION	DESCRIPTION	BENENNUNG	DESCRIPCION
			Solo per bancale regolabile	Only for adjustable stand	Seulement pour bâti réglable		
●▲	923958-4.00	1	gruppo dosatore-filtro	filter and dosimeter assembly	groupe doseur-filtre		
●	923805-4.01	1	gruppo filtro	filter assembly	groupe filtre		
1	902272-0.00	1	dado	nut	écrou		
2	721484-2.00	4	vite	screw	vis		
3	704011-4.00	1	rondella	washer	rondelle		
4	720485-4.00	1	vite	screw	vis		
5	923802-0.00	1	nippio	nipple	raccord à vis		
6	923800-0.00	1	dosatore	dosimeter	doseur		
7	923803-0.00	2	raccordo	pipe-connection	raccord		
8	924870-0.10	1	attacco	pipe union	raccord		
9	704306-2.00	2	rondella	washer	rondelle		
10	746007-2.00	2	dado	nut	écrou		
11	925513-0.00	2	squadretta	bracket	équerre		
12	741082-2.00	2	vite	screw	vis		
13	703005-0.00	4	rondella	washer	rondelle		
14	733505-2.00	4	dado	nut	écrou		
15	923804-0.00	1	attacco	pipe union	raccord		
16	924991-0.00	1	guarnizione	gasket	garniture		
17	924992-0.00	1	tazza	container	tasse		
18	924990-0.00	1	guarnizione	gasket	garniture		
19	923801-4.00	1	filtro aria completo	air filter assembly	filtre aire complet		
20	990441-0.10	2	cinturino	strap	bride		
21	990442-0.10	2	bottoncino	button	bouton		
			Solo per bancale a colonna	Only for column stand	Seulement pour bâti a colonne		
■	923805-4.01	1	gruppo filtro	filter assembly	groupe filtre		
22	923802-0.00	1	nippio	nipple	raccord à vis		
23	923800-0.00	1	dosatore	dosimeter	doseur		
24	923803-0.00	2	raccordo	pipe connection	raccord		
25	924870-0.10	1	attacco	pipe union	raccord		
26	731105-0.00	4	vite	screw	vis		
27	923804-0.00	1	attacco	pipe union	raccord		
28	924991-0.00	1	guarnizione	gasket	garniture		
29	924992-0.00	1	tazza	container	tasse		
30	924990-0.00	1	guarnizione	gasket	garniture		
31	923801-4.00	1	filtro aria completo	air filter assembly	filtre aire complet		
32	920258-0.10	1	cinturino	strap	bride		

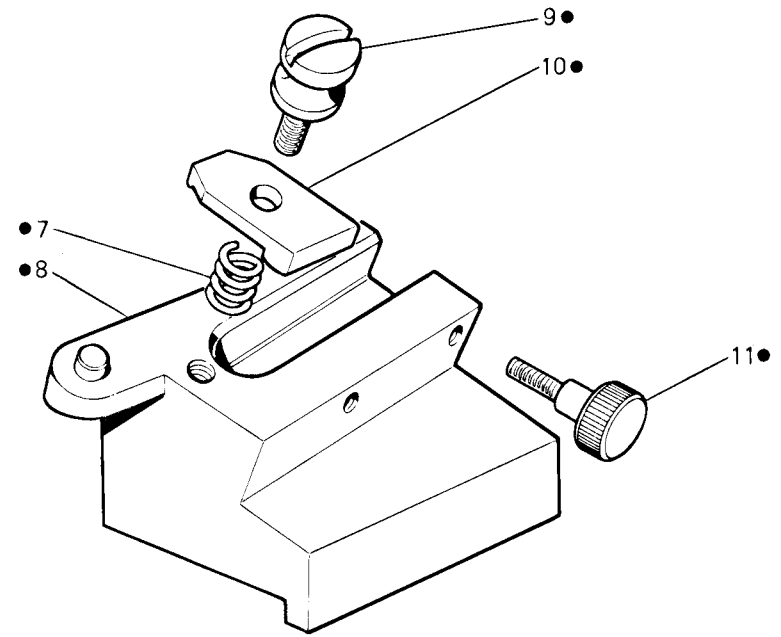
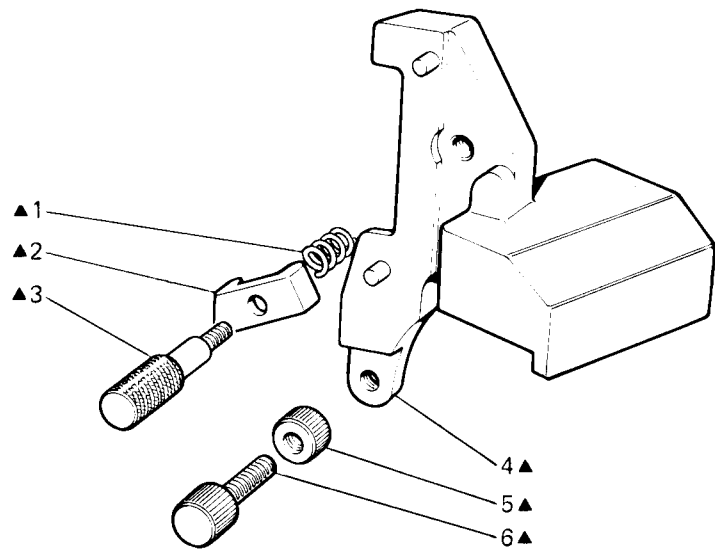
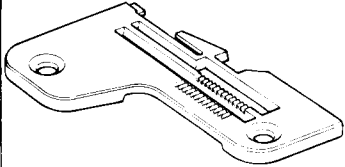
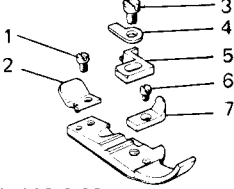
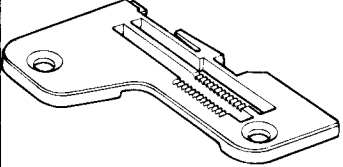
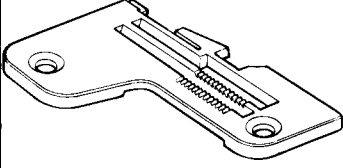
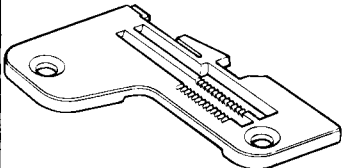
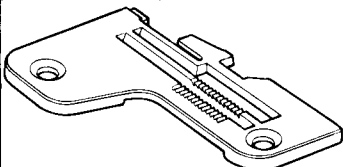
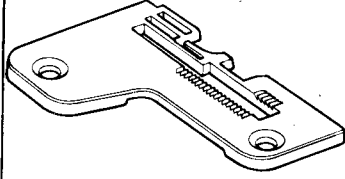
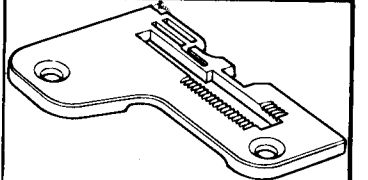
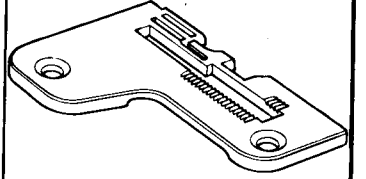
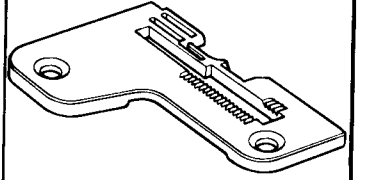
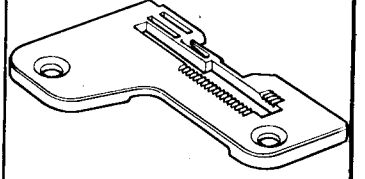

Fig. N. Abb. N.	Part. N. Bestell N. Pieze N. Pieza N.	Qt. Anzahl	DESCRIZIONE	DESCRIPTION	DESCRIPTION	BENENNUNG	DESCRIPCION
			SOLO A RICHIESTA	ONLY ON REQUEST	SEULEMENT SUR DEMANDE		
▲	990654-4-00	1	affila coltelli completo (coltello fisso)	sharpener assembly (immovable knife)	affûteuse complète (couteau fixe)		
●	990630-4-00	1	affila coltelli completo (coltello mobile)	sharpener assembly (movable knife)	affûteuse complète (couteau mobile)		
1	990669-0-00	1	molla	spring	ressort		
2	990668-0-00	1	staffa	bracket	bride		
3	990659-0-00	1	pomolo	knob	pommeau		
4	990658-2-00	1	blocchetto	block	bloc		
5	991016-0-00	1	ghiera	ring nut	collier		
6	991015-0-00	1	pomolo	knob	pommeau		
7	301561-0-10	1	molla	spring	ressort		
8	990634-2-00	1	blocchetto	block	bloc		
9	300917-0-10	1	pomolo	knob	pommeau		
10	990633-0-00	1	staffa	bracket	bride		
11	990504-0-00	1	pomolo	knob	pommeau		



TAV. 5

PER TESTA FOR HEAD POUR TETE FUER OBERTEIL		IN DOTAZIONE – EQUIPMENT – EN DOTATION – NORMALAUESRUSTUNG				A RICHIESTA · ON REQUEST · SUR DEMANDE · AUF ANFRAGE			
		PIEDINO PRESSER-FOOT PIED-PRESSEUR FUESSEN	PLACCA AGO NEEDLE PLATE PLAQUE A AIGUILLE STICHPLATTE	GRIFFA FEED DOG GRIFFE TRANSPORTEUR	GRIFFINO FEED DOG GRIFFE TRANSPORTEUR	PIEDINO PRESSER-FOOT PIED-PRESSEUR FUESSEN	PLACCA AGO NEEDLE PLATE PLAQUE A AIGUILLE STICHPLATTE		
527-00-1CD-01									
			923230-0-00			926088-3-00	923215-0-00		
								923221-0-00	
								923236-0-00	
							923237-0-00		
Fig. N. Abb. N.	Part. N. Piec N. Bestell N.	Qt. Anzahl	DESCRIZIONE	DESCRIPTION	Fig. N. Abb. N.	Part. N. Piec N. Bestell N.	Qt. Anzahl	DESCRIZIONE	DESCRIPTION
1	741413-2-00	1	vite	screw					
2	202192-0-10	1	piastrina	plate					
3	741665-2-00	1	vite	screw					
4	202201-0-11	1	staffa	bracket					
5	202195-0-11	1	linguetta	tongue					
6	741431-2-00	1	vite	screw					
7	202184-0-11	1	blocchetto	block					

PER TESTA FOR HEAD POUR TETE FUER OBERTEIL			IN DOTAZIONE – EQUIPMENT – EN DOTATION – NORMALAUSRUSTUNG				A RICHIESTA · ON REQUEST · SUR DEMANDE · AUF ANFRAGE			
			PIEDINO PRESSER-FOOT PIED-PRESSEUR FUSSCHEN	PLACCA AGO NEEDLE PLATE PLAQUE A AIGUILLE STICHPLATTE	GRIFFA FEED DOG GRIFFE TRANSPORTEUR	GRIFFINO FEED DOG GRIFFE TRANSPORTEUR	PIEDINO PRESSER-FOOT PIED-PRESSEUR FUSSCHEN	PLACCA AGO NEEDLE PLATE PLAQUE A AIGUILLE STICHPLATTE		
527.00-1CD-02				 923192-0-00				 923185-0-00		
							 923186-0-00			
							 923187-0-00			
							 923188-0-00			
Fig. N. Abb. N.	Part. N. Piece N. Bestell N.	Qt. Anzahl	DESCRIZIONE	DESCRIPTION	Fig. N. Abb. N.	Part. N. Piece N. Bestell N.	Qt. Anzahl	DESCRIZIONE	DESCRIPTION	

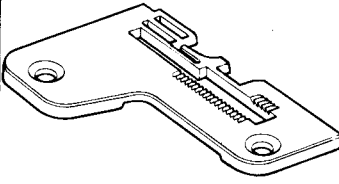
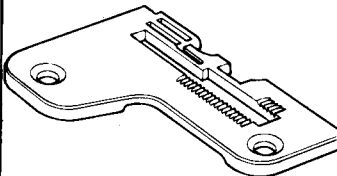
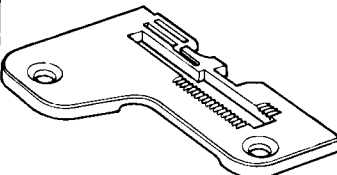
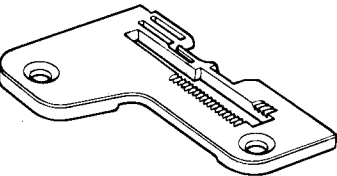
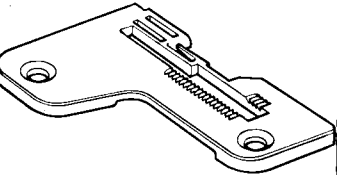
TAV. 7

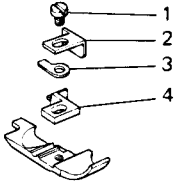
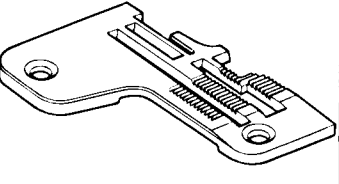
PER TESTA FOR HEAD POUR TETE FUER OBERTEIL			IN DOTAZIONE – EQUIPMENT – EN DOTATION – NORMALAUESRUSTUNG				A RICHIESTA - ON REQUEST - SUR DEMANDE - AUF ANFRAGE			
			PIEDINO PRESSER-FOOT PIED-PRESSEUR FUESSCHEN	PLACCA AGO NEEDLE PLATE PLAQUE A AIGUILLE STICHPLATTE	GRIFFA FEED DOG GRIFFE TRANSPORTEUR	GRIFFINO FEED DOG GRIFFE TRANSPORTEUR	PIEDINO PRESSER-FOOT PIED-PRESSEUR FUESSCHEN	PLACCA AGO NEEDLE PLATE PLAQUE A AIGUILLE STICHPLATTE		
527-00-1CD-05				 923192-0-00				 923185-0-00		
							 923186-0-00			
							 923187-0-00			
							 923188-0-00			
Fig. N. Abb. N.	Part. N. Piece N. Bestell N.	Qt. Anzahl	DESCRIZIONE	DESCRIPTION	Fig. N. Abb. N.	Part. N. Piece N. Bestell N.	Qt. Anzahl	DESCRIZIONE	DESCRIPTION	

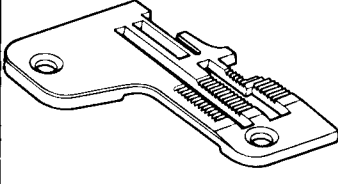
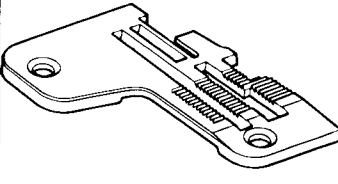
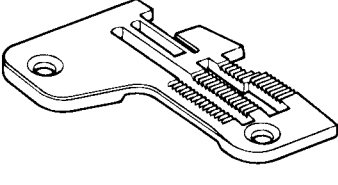
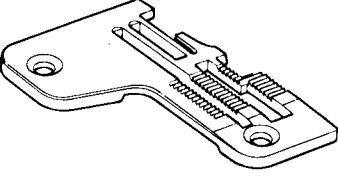
PER TESTA FOR HEAD POUR TETE FUER OBERTEIL		IN DOTAZIONE – EQUIPMENT – EN DOTATION – NORMALAUESRUSTUNG				A RICHIESTA - ON REQUEST - SUR DEMANDE - AUF ANFRAGE			
		PIEDINO PRESSER-FOOT PIED-PRESSEUR FUSSCHEN	PLACCA AGO NEEDLE PLATE PLAQUE A AIGUILLE STICHPLATTE	GRIFFA FEED DOG GRIFFE TRANPORTEUR	GRIFFINO FEED DOG GRIFFE TRANPORTEUR			PIEDINO PRESSER-FOOT PIED-PRESSEUR FUSSCHEN	PLACCA AGO NEEDLE PLATE PLAQUE A AIGUILLE STICHPLATTE
527-00-1CD-06									
		926085-3-00	923220-0-00		926093-0-00		923218-0-00		
									
									
									
						923243-0-00			
Fig. N. Abb. N.	Part. N. Piece N. Bestell N.	Qt. Anzahl	DESCRIZIONE	DESCRIPTION	Fig. N. Abb. N.	Part. N. Piece N. Bestell N.	Qt. Anzahl	DESCRIZIONE	DESCRIPTION
1	741675-2-00	1	vite	screw					
2	203021-0-11	1	piastrina	plate					
3	202201-0-11	1	staffa	bracket					
4	203026-0-11	1	linguetta	tongue					

TAV. 9

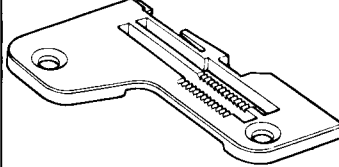
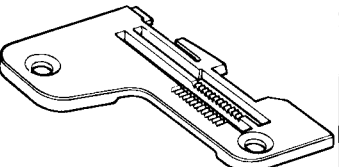
PER TESTA FOR HEAD POUR TETE FUER OBERTEIL			IN DOTAZIONE - EQUIPMENT - EN DOTATION - NORMALAUESRUSTUNG				A RICHIESTA - ON REQUEST - SUR DEMANDE - AUF ANFRAGE							
			PIEDINO PRESSER-FOOT PIED-PRESSEUR FUESCHEN		PLACCA AGO NEEDLE PLATE PLAQUE A AIGUILLE STICHPLATTE		GRIFFA FEED DOG GRIFFE TRANSPORTEUR		GRIFFINO FEED DOG GRIFFE TRANSPORTEUR		PIEDINO PRESSER-FOOT PIED-PRESSEUR FUESCHEN		PLACCA AGO NEEDLE PLATE PLAQUE A AIGUILLE STICHPLATTE	
527-00-1CD-07					923225-0-00								923226-0-00	
Fig. N. Abb. N.	Part. N. Piece N. Bestell N.	Qt. Anzahl	DESCRIZIONE	DESCRIPTION	Fig. N. Abb. N.	Part. N. Piece N. Bestell N.	Qt. Anzahl	DESCRIZIONE	DESCRIPTION					

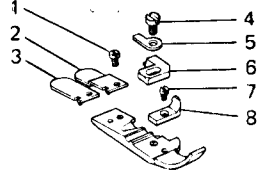
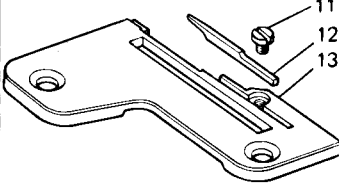
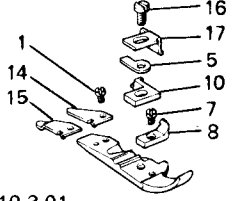
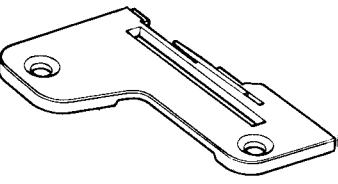
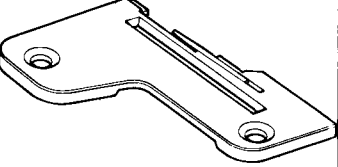
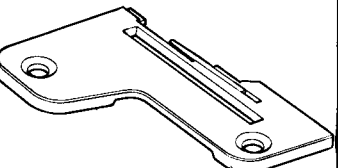
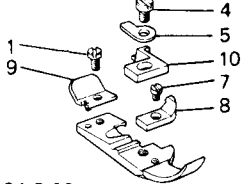
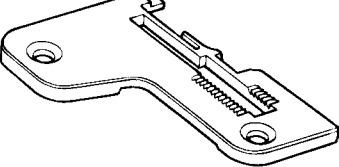

PER TESTA FOR HEAD POUR TETE FUER OBERTEIL		IN DOTAZIONE – EQUIPMENT – EN DOTATION – NORMALAUESRUSTUNG				A RICHIESTA - ON REQUEST - SUR DEMANDE - AUF ANFRAGE							
		PIEDINO PRESSER-FOOT PIED-PRESSEUR FUESSCHEN		PLACCA AGO NEEDLE PLATE PLAQUE A AIGUILLE STICHPLATTE		GRIFFA FEED DOG GRIFFE TRANSPORTEUR		GRIFFINO FEED DOG GRIFFE TRANSPORTEUR		PIEDINO PRESSER-FOOT PIED-PRESSEUR FUESSCHEN		PLACCA AGO NEEDLE PLATE PLAQUE A AIGUILLE STICHPLATTE	
527-00-1CD-09													
		926092-3-00		923211-4-00						923910-3-01		923200-2-00	
													
												923202-2-00	
													
												923205-2-00	
527-00-1CD-10													
		926094-3-00		923184-0-00									
Fig. N Abb. N	Part N Piecce N. Bestell N	Qt. Anzahl	DESCRIZIONE	DESCRIPTION	Fig. N. Abb. N.	Part. N. Piecce N. Bestell N.	Qt. Anzahl	DESCRIZIONE	DESCRIPTION				
1	741413-2-00	3	vite	screw	11	203382-0-10	1	vite	screw				
2	921448-0-10	1	piastrina	plate	12	203357-0-10	1	linguetta	tongue				
3	921444-0-10	1	piastrina	plate	13	923210-0-00	1	placca ago	needle plate				
4	741665-2-00	2	vite	screw	14	921515-0-00	1	piastrina	plate				
5	202201-0-11	3	staffa	bracket	15	921532-0-10	1	piastrina	plate				
6	203377-0-11	1	linguetta	tongue	16	741675-2-00	1	vite	screw				
7	741431-2-00	3	vite	screw	17	203483-0-11	1	piastrina	plate				
8	202184-0-11	3	blocchetto	block									
9	202192-0-10	1	piastrina	plate									
10	203378-0-11	2	linguetta	tongue									

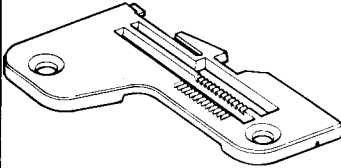
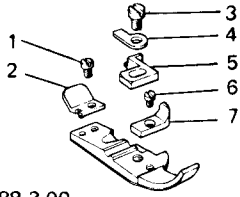
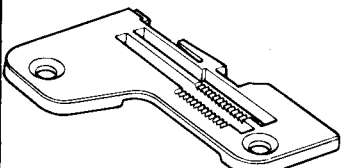
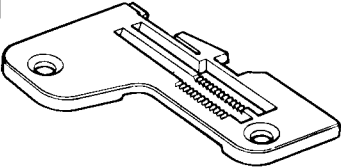
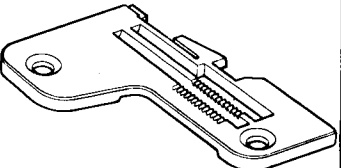
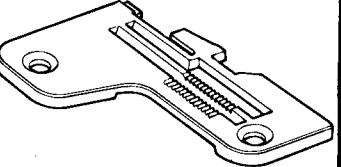
TAV. 11

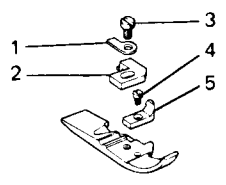
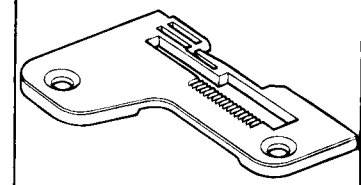
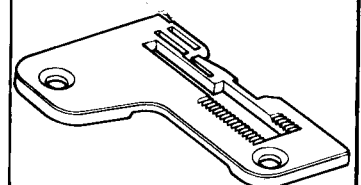
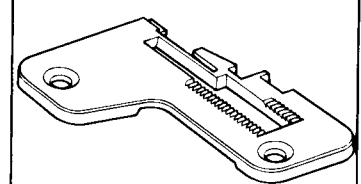
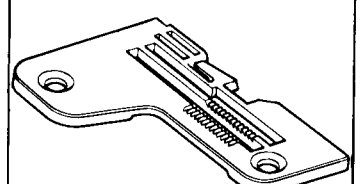
PER TESTA FOR HEAD POUR TETE FUER OBERTEIL		IN DOTAZIONE – EQUIPMENT – EN DOTATION – NORMALAUESRUSTUNG				A RICHIESTA - ON REQUEST - SUR DEMANDE - AUF ANFRAGE			
		PIEDINO PRESSER-FOOT PIED-PRESSEUR FUESSCHEN	PLACCA AGO NEEDLE PLATE PLAQUE A AIGUILLE STICHPLATTE	GRIFFA FEED DOG GRIFFE TRANSPORTEUR	GRIFFINO FEED DOG GRIFFE TRANSPORTEUR	PIEDINO PRESSER-FOOT PIED-PRESSEUR FUESSCHEN	PLACCA AGO NEEDLE PLATE PLAQUE A AIGUILLE STICHPLATTE		
527-00-1CD-20									
			923230-0-00			926088-3-00	923215-0-00		
								923221-0-00	
								923236-0-00	
							923237-0-00		
Fig. N. Abb. N.	Part. N. Piecce N. Bestell N.	Qt. Anzahl	DESCRIZIONE	DESCRIPTION	Fig. N. Abb. N.	Part. N. Piecce N. Bestell N.	Qt. Anzahl	DESCRIZIONE	DESCRIPTION
1	741413-2-00	1	vite	screw					
2	202192-0-10	1	piastrina	plate					
3	741665-2-00	1	vite	screw					
4	202201-0-11	1	staffa	bracket					
5	202195-0-11	1	linguetta	tongue					
6	741431-2-00	1	vite	screw					
7	202184-0-11	1	blocchetto	block					

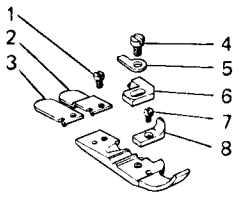
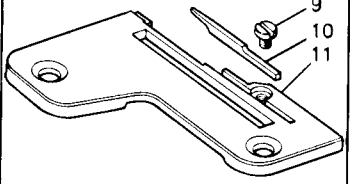
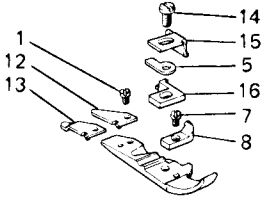
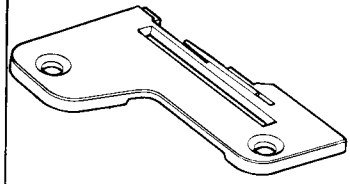
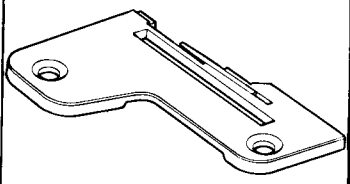
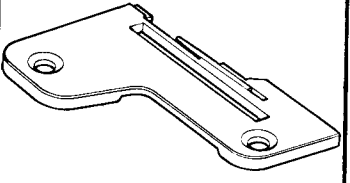

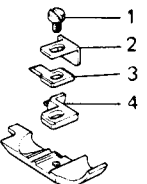
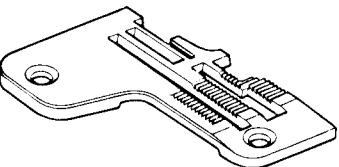
PER TESTA FOR HEAD POUR TETE FUER OBERTEIL		IN DOTAZIONE - EQUIPMENT - EN DOTATION - NORMALAUESRUSTUNG				A RICHIESTA - ON REQUEST - SUR DEMANDE - AUF ANFRAGE			
		PIEDINO PRESSER-FOOT PIED-PRESSEUR FUSSCHEN	PLACCA AGO NEEDLE PLATE PLAQUE A AIGUILLE STICHPLATTE	GRIFFA FEED DOG GRIFFE TRANSPORTEUR	GRIFFINO FEED DOG GRIFFE TRANSPORTEUR	PIEDINO PRESSER-FOOT PIED-PRESSEUR FUSSCHEN	PLACCA AGO NEEDLE PLATE PLAQUE A AIGUILLE STICHPLATTE		
527-00-1CD-25		 926078-3-00	 923178-0-00				 923176-0-00		
527-00-1CD-29			 923222-0-00						
527-00-1CD-31			 923182-0-00						
Fig. N. Abb. N.	Part. N. Piecce N. Bestell N.	Qt. Anzahl	DESCRIZIONE	DESCRIPTION	Fig. N. Abb. N.	Part. N. Piecce N. Bestell N.	Qt. Anzahl	DESCRIZIONE	DESCRIPTION
1	202201-0-11	1	staffa	bracket					
2	203052-0-11	1	linguetta	tongue					
3	741665-2-00	1	vite	screw					
4	741431-2-00	1	vite	screw					
5	202184-0-11	1	blocchetto	block					

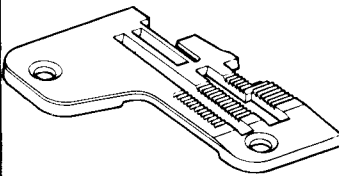
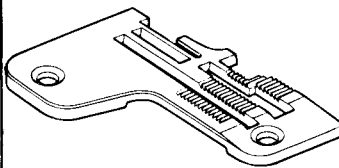
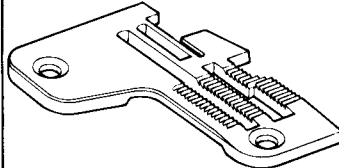
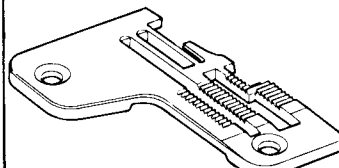

PER TESTA FOR HEAD POUR TETE FUER OBERTEIL		IN DOTAZIONE - EQUIPMENT - EN DOTATION - NORMALAUESRUSTUNG				A RICHIESTA - ON REQUEST - SUR DEMANDE - AUF ANFRAGE			
		PIEDINO PRESSER-FOOT PIED-PRESSEUR FUESSCHEN	PLACCA AGO NEEDLE PLATE PLAQUE A AIGUILLE STICHPLATTE	GRIFFA FEED DOG GRIFFE TRANSPORTEUR	GRIFFINO FEED DOG GRIFFE TRANSPORTEUR	PIEDINO PRESSER-FOOT PIED-PRESSEUR FUESSCHEN	PLACCA AGO NEEDLE PLATE PLAQUE A AIGUILLE STICHPLATTE		
527-00-1CD-39									
		926092-3-00	923211-4-00			923910-3-01	923200-2-00		
									
							923202-2-00		
									
						923205-2-00			
Fig. N. Abb. N.	Part. N. Piece N. Bestell N.	Qt. Anzahl	DESCRIZIONE	DESCRIPTION	Fig. N. Abb. N.	Part. N. Piece N. Bestell N.	Qt. Anzahl	DESCRIZIONE	DESCRIPTION
1	741413-2-00	2	vite	screw	11	923210-0-00	1	placca ago	needle plate
2	921448-0-10	1	piastrina	plate	12	921515-0-00	1	piastrina	plate
3	921444-0-10	1	piastrina	plate	13	921532-0-10	1	piastrina	plate
4	741665-2-00	1	vite	screw	14	741675-2-00	1	vite	screw
5	202201-0-11	2	staffa	bracket	15	203483-0-11	1	piastrina	plate
6	203377-0-11	1	linguetta	tongue	16	203378-0-11	1	linguetta	tongue
7	741431-2-00	2	vite	screw					
8	202184-0-11	2	blocchetto	block					
9	203382-0-10	1	vite	screw					
10	203357-0-10	1	linguetta	tongue					

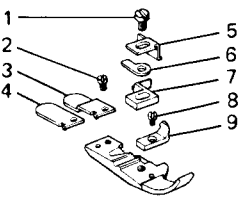
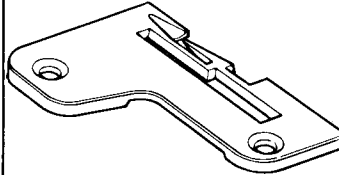
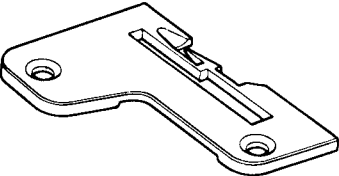
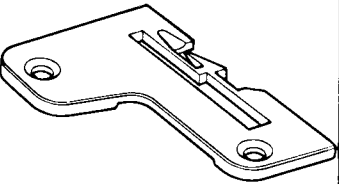
PER TESTA FOR HEAD POUR TETE FUER OBERTEIL		IN DOTAZIONE – EQUIPMENT – EN DOTATION – NORMALAUESRUSTUNG				A RICHIESTA - ON REQUEST - SUR DEMANDE - AUF ANFRAGE			
		PIEDINO PRESSER-FOOT PIED-PRESSEUR FUESSCHEN	PLACCA AGO NEEDLE PLATE PLAQUE A AIGUILLE STICHPLATTE	GRIFFA FEED DOG GRIFFE TRANSPORTEUR	GRIFFINO FEED DOG GRIFFE TRANSPORTEUR	PIEDINO PRESSER-FOOT PIED-PRESSEUR FUESSCHEN	PLACCA AGO NEEDLE PLATE PLAQUE A AIGUILLE STICHPLATTE		
527-00-1MD-23		 926087-3-00	 923218-0-00		 926093-0-00		 923219-0-00		
						 923220-0-00			
						 923224-0-00			
						 923243-0-00			
Fig. N. Abb. N.	Part. N. Piece N. Bestell N.	Qt. Anzahl	DESCRIZIONE	DESCRIPTION	Fig. N. Abb. N.	Part. N. Piece N. Bestell N.	Qt. Anzahl	DESCRIZIONE	DESCRIPTION
1	741685-2-00	1	vite	screw					
2	203768-0-11	1	piastrina	plate					
3	203772-0-11	1	staffa	bracket					
4	203771-0-11	1	linguetta	tongue					

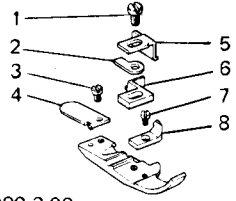
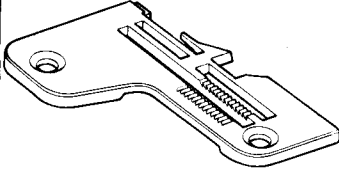
TAV. 15

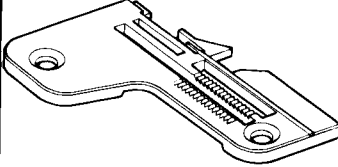
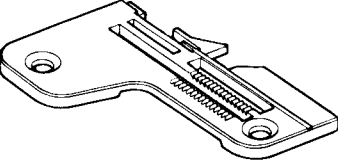
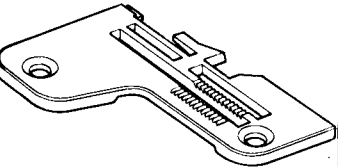
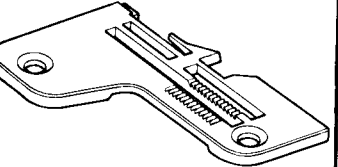
PER TESTA FOR HEAD POUR TETE FUER OBERTEIL			IN DOTAZIONE – EQUIPMENT – EN DOTATION – NORMALAUESRUSTUNG				A RICHIESTA · ON REQUEST · SUR DEMANDE · AUF ANFRAGE							
			PIEDINO PRESSER-FOOT PIED-PRESSEUR FUESSCHEN		PLACCA AGO NEEDLE PLATE PLAQUE A AIGUILLE STICHPLATTE		GRIFFA FEED DOG GRIFFE TRANSPORTEUR		GRIFFINO FEED DOG GRIFFE TRANSPORTEUR		PIEDINO PRESSER-FOOT PIED-PRESSEUR FUESSCHEN		PLACCA AGO NEEDLE PLATE PLAQUE A AIGUILLE STICHPLATTE	
527-00-2CD-12														
			926089-3-00		923194-0-00								923191-0-00	
														
												923193-0-00		
Fig. N. Abb. N.	Part. N. Pierce N. Bestell N.	Qt. Anzahl	DESCRIZIONE	DESCRIPTION	Fig. N. Abb. N.	Part. N. Pierce N. Bestell N.	Qt. Anzahl	DESCRIZIONE	DESCRIPTION					
1	741675-2-00	1	vite	screw										
2	741413-2-00	1	vite	screw										
3	921459-0-10	1	piastrina	plate										
4	921444-0-10	1	piastrina	plate										
5	203483-0-11	1	piastrina	plate										
6	202201-0-11	1	staffa	bracket										
7	203453-0-11	1	linguetta	tongue										
8	741413-2-00	1	vite	screw										
9	202184-0-11	1	blocchetto	block										

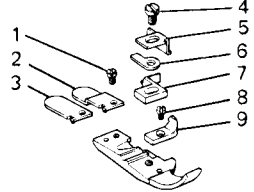
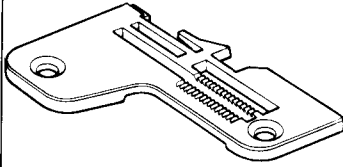
PER TESTA FOR HEAD POUR TETE FUER OBERTEIL		IN DOTAZIONE - EQUIPMENT - EN DOTATION - NORMALAUESRUSTUNG				A RICHIESTA - ON REQUEST - SUR DEMANDE - AUF ANFRAGE			
		PIEDINO PRESSER-FOOT PIED-PRESSEUR FUESSCHEN	PLACCA AGO NEEDLE PLATE PLAQUE A AIGUILLE STICHPLATTE	GRIFFA FEED DOG GRIFFE TRANSPORTEUR	GRIFFINO FEED DOG GRIFFE TRANSPORTEUR	PIEDINO PRESSER-FOOT PIED-PRESSEUR FUESSCHEN	PLACCA AGO NEEDLE PLATE PLAQUE A AIGUILLE STICHPLATTE		
527-00-2CD-13		 <p>1 2 3 4 5 6 7 8</p> <p>926090-3-00</p>	 <p>923216-0-00</p>		 <p>926093-0-00</p>		 <p>923207-2-00</p>		
						 <p>923209-2-00</p>			
						 <p>923217-0-00</p>			
						 <p>923239-0-00</p>			
Fig. N. Abb. N.	Part. N. Piece N. Bestell N.	Qt. Anzahl	DESCRIZIONE	DESCRIPTION	Fig. N. Abb. N.	Part. N. Piece N. Bestell N.	Qt. Anzahl	DESCRIZIONE	DESCRIPTION
1	741675-2-00	1	vite	screw					
2	202201-0-11	1	staffa	bracket					
3	741413-2-00	1	vite	screw					
4	921444-0-10	1	piastrina	plate					
5	203483-0-11	1	piastrina	plate					
6	203453-0-11	1	linguetta	tongue					
7	741431-2-00	1	vite	screw					
8	202184-0-11	1	blocchetto	block					

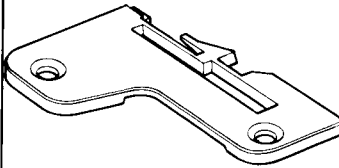
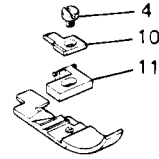
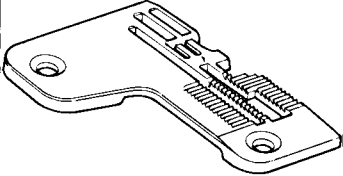
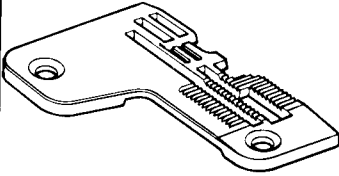
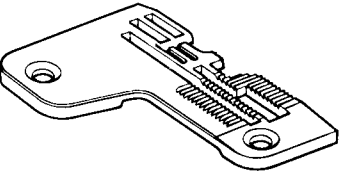
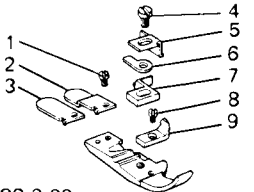
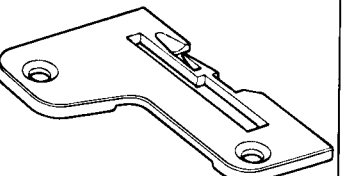
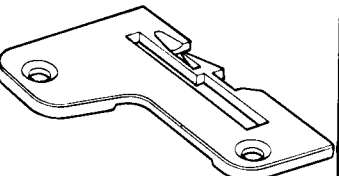
PER TESTA FOR HEAD POUR TETE FUER OBERTEIL		IN DOTAZIONE - EQUIPMENT - EN DOTATION - NORMALAUESRUSTUNG					A RICHIESTA - ON REQUEST - SUR DEMANDE - AUF ANFRAGE		
		PIEDINO PRESSER-FOOT PIED-PRESSEUR FUESSCHEN	PLACCA AGO NEEDLE PLATE PLAQUE A AIGUILLE STICHPLATTE	GRIFFA FEED DOG GRIFFE TRANSPORTEUR	GRIFFINO FEED DOG GRIFFE TRANSPORTEUR	PIEDINO PRESSER-FOOT PIED-PRESSEUR FUESSCHEN	PLACCA AGO NEEDLE PLATE PLAQUE A AIGUILLE STICHPLATTE		
527-00-2CD-38	 926089-3-00	 923234-0-00		 926093-0-00		 923203-0-00			
527-00-2CD-41	 926080-3-00	 923180-0-00			 923177-0-00				
					 923181-0-00				
527-00-2CD-44	 926089-3-00	 923191-0-00			 923193-0-00				
Fig. N. Abb. N.	Part. N. Piecè N. Bestell N.	Qt. Anzahl	DESCRIZIONE	DESCRIPTION	Fig. N. Abb. N.	Part. N. Piecè N. Bestell N.	Qt. Anzahl	DESCRIZIONE	DESCRIPTION
1	741413-2-00	1	vite	screw					
2	921459-0-10	1	piastrina	plate					
3	921444-0-10	1	piastrina	plate					
4	741675-2-00	2	vite	screw					
5	203483-0-11	1	piastrina	plate					
6	202201-0-11	1	staffa	bracket					
7	203453-0-11	1	linguetta	tongue					
8	741431-2-00	1	vite	screw					
9	202184-0-11	1	blocchetto	block					
10	203772-0-11	1	staffa	bracket					
11	203569-0-11	1	linguetta	tongue					

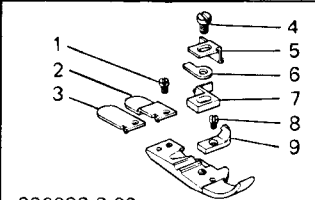
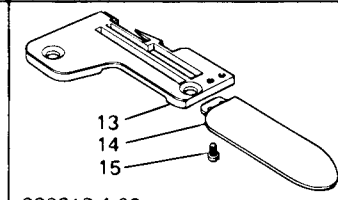
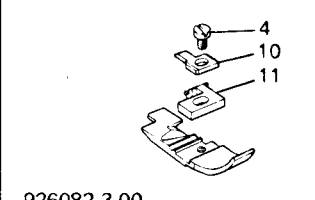
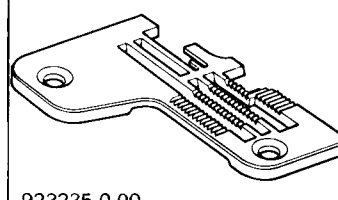
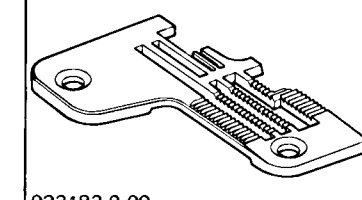
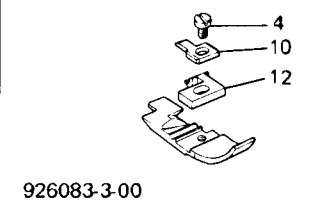
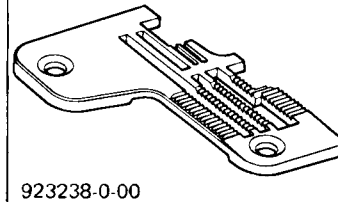
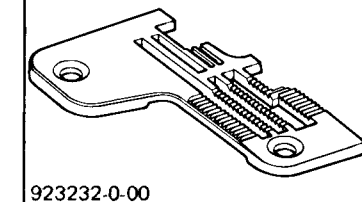
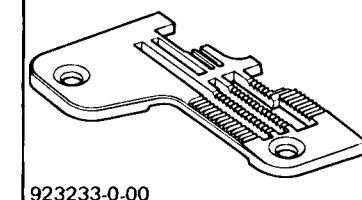
PER TESTA FOR HEAD POUR TETE FUER OBERTEIL			IN DOTAZIONE – EQUIPMENT – EN DOTATION – NORMALAUESRUSTUNG				A RICHIESTA - ON REQUEST - SUR DEMANDE - AUF ANFRAGE					
			PIEDINO PRESSER-FOOT PIED-PRESSEUR FUESSCHEN		PLACCA AGO NEEDLE PLATE PLAQUE A AIGUILLE STICHPLATTE		GRIFFA FEED DOG GRIFFE TRANSPORTEUR		GRIFFINO FEED DOG GRIFFE TRANSPORTEUR		PIEDINO PRESSER-FOOT PIED-PRESSEUR FUESSCHEN	
527-00-2CD-47			 926089-3-00		 923213-4-00							
527-00-2MD-20			 926082-3-00		 923235-0-00						 923183-0-00	
527-00-2MD-36			 926083-3-00		 923238-0-00						 923232-0-00	
											 923233-0-00	
Fig. N. Abb. N.	Part. N. Pierce N. Bestell N.	Qt. Anzahl	DESCRIZIONE	DESCRIPTION	Fig. N. Abb. N.	Part. N. Pierce N. Bestell N.	Qt. Anzahl	DESCRIZIONE	DESCRIPTION			
1	741413-2-00	1	vite	screw	11	203569-0-11	1	linguetta	tongue			
2	921459-0-10	1	piastrina	plate	12	204011-0-11	1	linguetta	tongue			
3	921444-0-10	1	piastrina	plate	13	923212-0-00	1	placca ago	needle plate			
4	741675-2-00	3	vite	screw	14	207157-0-00	1	prolunga	extension			
5	203483-0-11	1	piastrina	plate	15	741559-2-00	1	vite	screw			
6	202201-0-11	1	staffa	bracket								
7	203453-0-11	1	linguetta	tongue								
8	741431-2-00	1	vite	screw								
9	202184-0-11	1	blocchetto	block								
10	203772-0-11	2	staffa	bracket								

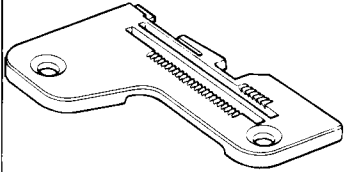
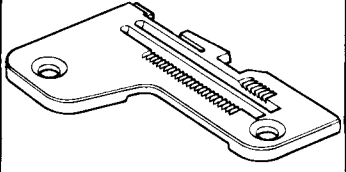
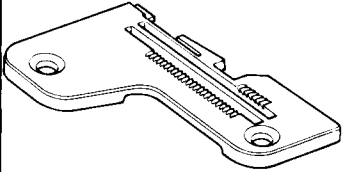
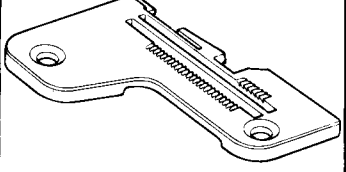
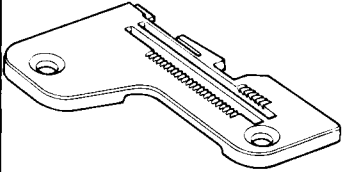
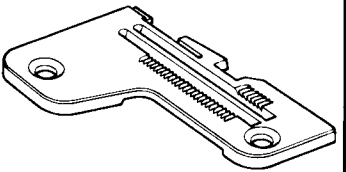
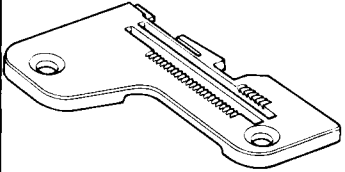
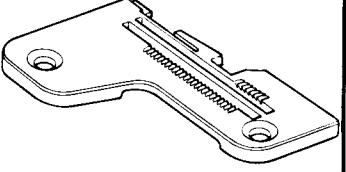
PER TESTA FOR HEAD POUR TETE FUER OBERTEIL			IN DOTAZIONE - EQUIPMENT - EN DOTATION - NORMALAUESRUSTUNG				A RICHIESTA - ON REQUEST - SUR DEMANDE - AUF ANFRAGE			
			PIEDINO PRESSER-FOOT PIED-PRESSEUR FUESSCHEN	PLACCA AGO NEEDLE PLATE PLAQUE A AIGUILLE STICHPLATTE	GRIFFA FEED DOG GRIFFE TRANSPORTEUR	GRIFFINO FEED DOG GRIFFE TRANSPORTEUR	PIEDINO PRESSER-FOOT PIED-PRESSEUR FUESSCHEN	PLACCA AGO NEEDLE PLATE PLAQUE A AIGUILLE STICHPLATTE		
527-10-1CD-02										
			923223-0-00				923229-0-00			
527-10-1CD-06										
			923223-0-00				923241-0-00			
527-10-1CD-06										
			923223-0-00				923229-0-00			
527-10-1CD-06										
			923223-0-00				923241-0-00			
Fig. N. Abb. N.	Part. N. Piecce N. Bestell N.	Qt. Anzahl	DESCRIZIONE	DESCRIPTION	Fig. N. Abb. N.	Part. N. Piecce N. Bestell N.	Qt. Anzahl	DESCRIZIONE	DESCRIPTION	

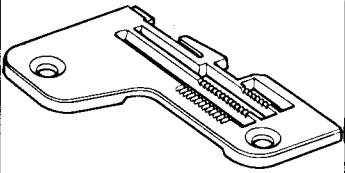
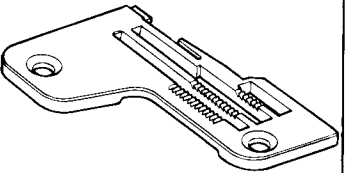
PER TESTA FOR HEAD POUR TETE FUER OBERTEIL			IN DOTAZIONE – EQUIPMENT – EN DOTATION – NORMALAUESRUSTUNG				A RICHIESTA - ON REQUEST - SUR DEMANDE - AUF ANFRAGE						
			PIEDINO PRESSER-FOOT PIED-PRESSEUR FUSSCHEN	PLACCA AGO NEEDLE PLATE PLAQUE A AIGUILLE STICHPLATTE	GRIFFA FEED DOG GRIFFE TRANSPORTEUR	GRIFFINO FEED DOG GRIFFE TRANSPORTEUR	PIEDINO PRESSER-FOOT PIED-PRESSEUR FUSSCHEN		PLACCA AGO NEEDLE PLATE PLAQUE A AIGUILLE STICHPLATTE				
527-22-1CD-02			 <p>923198-0-00</p>										
527-22-1CD-03							 <p>923214-0-00</p>						
Fig. N. Abb. N.	Part. N. Piece N. Bestell N.	Qt. Anzahl	DESCRIZIONE		DESCRIPTION		Fig. N. Abb. N.	Part. N. Piece N. Bestell N.	Qt. Anzahl	DESCRIZIONE		DESCRIPTION	

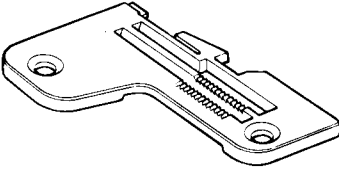
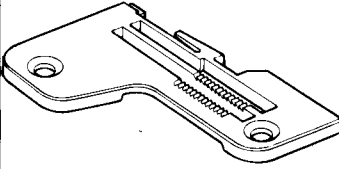
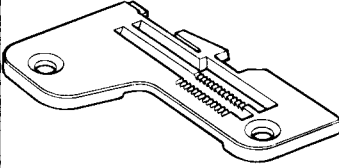
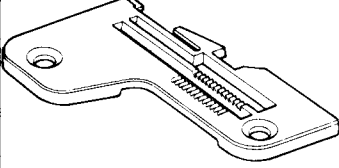
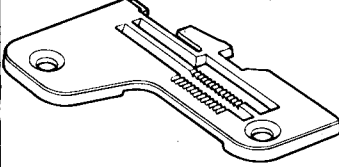
PER TESTA FOR HEAD POUR TETE FUER OBERTEIL		IN DOTAZIONE – EQUIPMENT – EN DOTATION – NORMALAUESRUSTUNG				A RICHIESTA - ON REQUEST - SUR DEMANDE - AUF ANFRAGE	
		PIEDINO PRESSER-FOOT PIED-PRESSEUR FUSSCHEN	PLACCA AGO NEEDLE PLATE PLAQUE A AIGUILLE STICHPLATTE	GRIFFA FEED DOG GRIFFE TRANSPORTEUR	GRIFFINO FEED DOG GRIFFE TRANSPORTEUR	PIEDINO PRESSER-FOOT PIED-PRESSEUR FUSSCHEN	PLACCA AGO NEEDLE PLATE PLAQUE A AIGUILLE STICHPLATTE
527-28-1CD-02			 923236-0-00				 923215-0-00
						 923221-0-00	
						 923230-0-00	
						 923237-0-00	
Fig. N. Abb. N.	Part. N. Piece N. Bestell N.	Qt. Anzahl	DESCRIZIONE DESCRIPTION	Fig. N. Abb. N.	Part. N. Piece N. Bestell N.	Qt. Anzahl	DESCRIZIONE DESCRIPTION

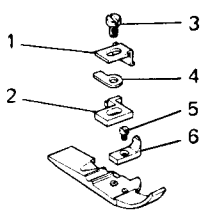
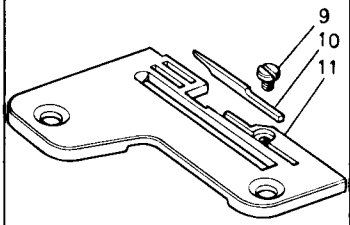
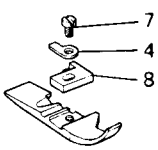
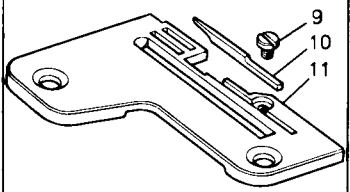
PER TESTA FOR HEAD POUR TETE FUER OBERTEIL		IN DOTAZIONE – EQUIPMENT – EN DOTATION – NORMALAUESRUSTUNG				A RICHIESTA - ON REQUEST - SUR DEMANDE - AUF ANFRAGE			
		PIEDINO PRESSER-FOOT PIED-PRESSEUR FUESSCHEN	PLACCA AGO NEEDLE PLATE PLAQUE A AIGUILLE STICHPLATTE	GRIFFA FEED DOG GRIFFE TRANSPORTEUR	GRIFFINO FEED DOG GRIFFE TRANSPORTEUR	PIEDINO PRESSER-FOOT PIED-PRESSEUR FUESSCHEN	PLACCA AGO NEEDLE PLATE PLAQUE A AIGUILLE STICHPLATTE		
527-28-1CD-07		 <p>926071-3-00</p>	 <p>923190-4-00</p>						
527-28-1CD-12		 <p>926076-3-00</p>	 <p>923190-4-00</p>						
Fig. N. Abb. N.	Part. N. Piecce N. Bestell N.	Qt. Anzahl	DESCRIZIONE	DESCRIPTION	Fig. N. Abb. N.	Part. N. Piecce N. Bestell N.	Qt. Anzahl	DESCRIZIONE	DESCRIPTION
1	202369-0-11	1	piastrina	plate					
2	203376-0-11	1	linguetta	tongue					
3	741675-2-00	1	vite	screw					
4	202201-0-11	2	staffa	bracket					
5	741431-2-00	1	vite	screw					
6	202184-0-11	1	blocchetto	block					
7	741665-2-00	1	vite	screw					
8	207102-0-01	1	linguetta	tongue					
9	203382-0-10	1	vite	screw					
10	203357-0-10	1	linguetta	tongue					
11	923861-0-10	1	placca ago	needle plate					

TAV.23

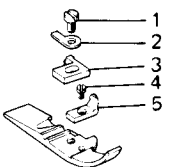
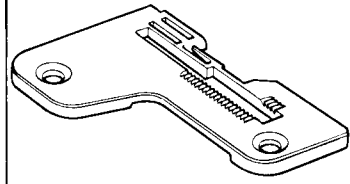
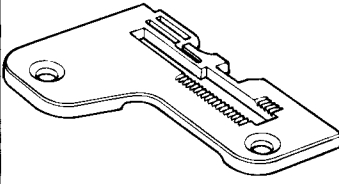
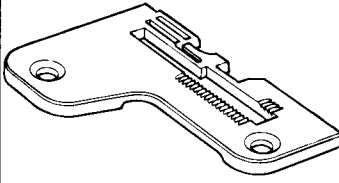
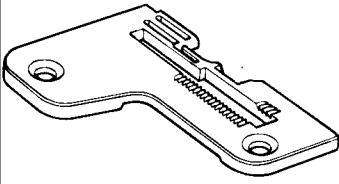
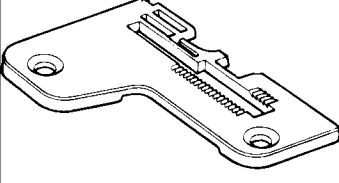
PER TESTA FOR HEAD POUR TETE FUER OBERTEIL	IN DOTAZIONE – EQUIPMENT – EN DOTATION – NORMALAUESRUSTUNG				A RICHIESTA - ON REQUEST - SUR DEMANDE - AUF ANFRAGE		
	PIEDINO PRESSER-FOOT PIED-PRESSEUR FUESSCHEN	PLACCA AGO NEEDLE PLATE PLAQUE A AIGUILLE STICHPLATTE	GRIFFA FEED DOG GRIFFE TRANSPORTEUR	GRIFFINO FEED DOG GRIFFE TRANSPORTEUR	PIEDINO PRESSER-FOOT PIED-PRESSEUR FUESSCHEN	PLACCA AGO NEEDLE PLATE PLAQUE A AIGUILLE STICHPLATTE	
527-28-1CD-09							
	926072-3-00	923188-0-00				923185-0-00	
							
						923186-0-00	
							
					923187-0-00		
							
					923192-0-00		
Fig. N. Abb. N.	Part. N. Piecce N. Bestell N.	Qt. Anzahl	DESCRIZIONE DESCRIPTION	Fig. N. Abb. N.	Part. N. Piecce N. Bestell N.	Qt. Anzahl	DESCRIZIONE DESCRIPTION
1	741665-2-00	1	vite screw				
2	202201-0-11	1	staffa bracket				
3	202661-0-11	1	linguetta tongue				
4	741431-2-00	1	vite screw				
5	202184-0-11	1	blocchetto block				

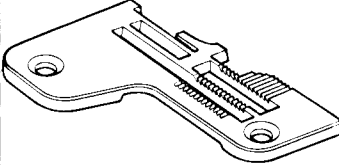
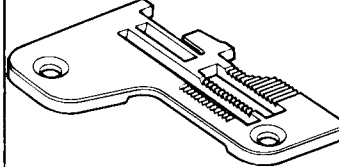
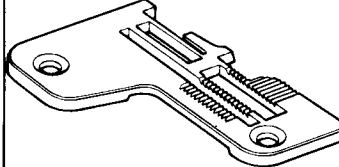
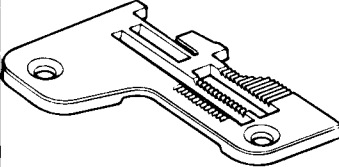
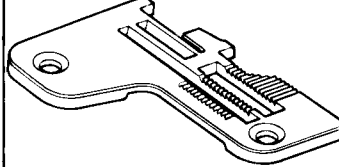
PER TESTA FOR HEAD POUR TETE FUER OBERTEIL			IN DOTAZIONE – EQUIPMENT – EN DOTATION – NORMALAUESRUSTUNG				A RICHIESTA - ON REQUEST - SUR DEMANDE - AUF ANFRAGE				
			PIEDINO PRESSER-FOOT PIED-PRESSEUR FUSSCHEN	PLACCA AGO NEEDLE PLATE PLAQUE A AIGUILLE STICHPLATTE	GRIFFA FEED DOG GRIFFE TRANSPORTEUR	GRIFFINO FEED DOG GRIFFE TRANSPORTEUR	PIEDINO PRESSER-FOOT PIED-PRESSEUR FUSSCHEN	PLACCA AGO NEEDLE PLATE PLAQUE A AIGUILLE STICHPLATTE			
527-28-1CU-04			 923227-0-00				 923228-0-00				
											 923242-0-00
527-28-1CU-06			 923240-0-00				 923228-0-00				
Fig. N. Abb. N.	Part. N. Piece N. Bestell N.	Qt. Anzahl	DESCRIZIONE		DESCRIPTION	Fig. N. Abb. N.	Part. N. Piece N. Bestell N.	Qt. Anzahl	DESCRIZIONE		DESCRIPTION

APPARECCHIATURA ATTACHMENT DISPOSITIF VORRICHTUNG

136-81

PER TESTE	527-00-1CD-30	529-00-2CS-06
FOR HEADS	527-00-1CD-50	529-00-2MD-01
POUR TETES	527-00-1MD-33	529-00-2MD-06
FUER OBERTEILE	527-01-2CD-20	529-00-2MD-07
	527-49-1MD-01	529-00-2MD-10
		529-00-2MD-13
	529-00-2CD-01	529-00-2MD-17
	529-00-2CD-03	529-00-2MD-23
	529-00-2CD-04	529-00-2MS-03
	529-00-2CD-05	529-00-2MS-07
	529-00-2CD-08	529-22-2CD-03
	529-00-2CD-12	529-22-2MD-04
	529-00-2CD-15	529-49-2MD-01
	529-00-2CD-22	

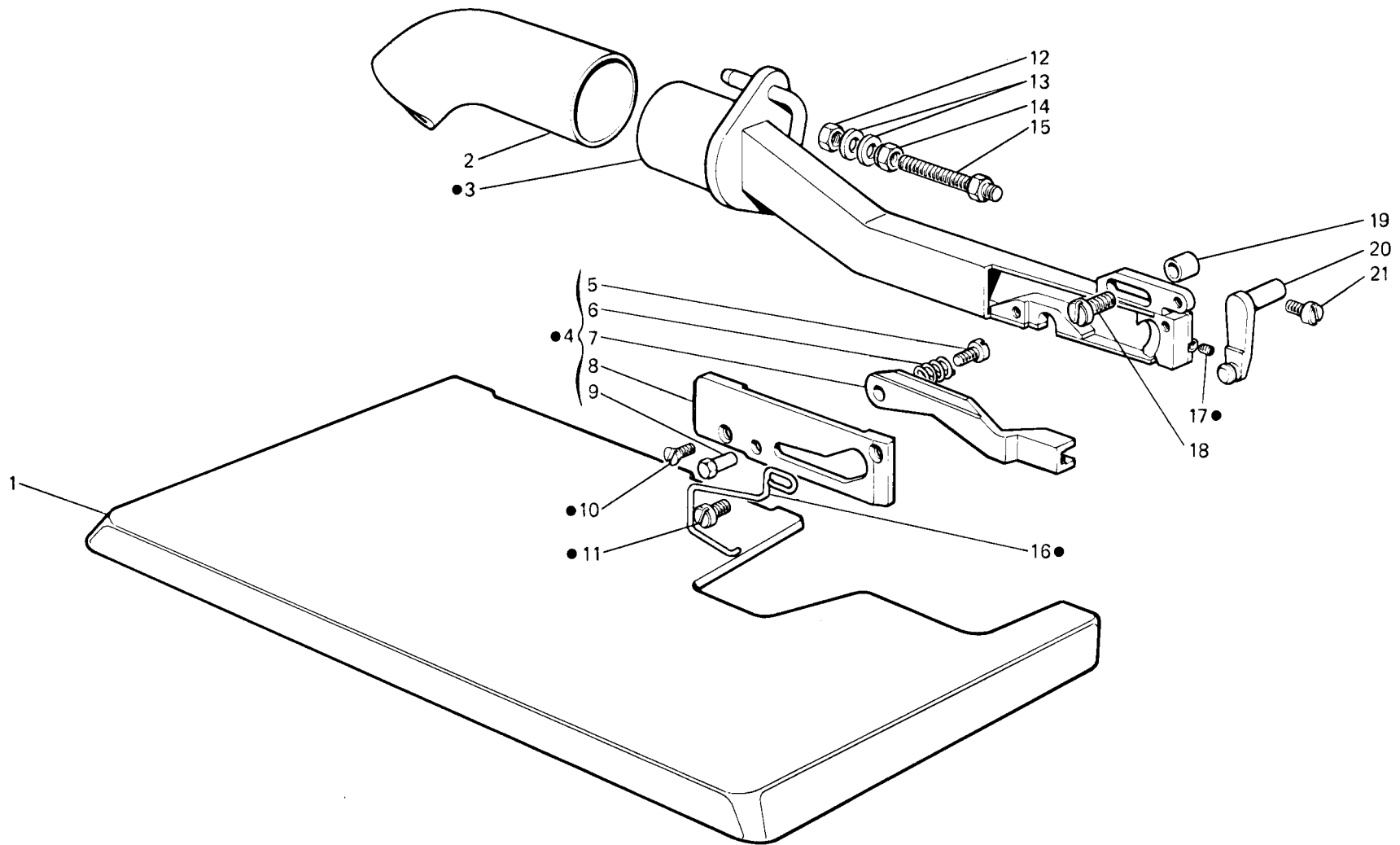

Fig. N. Abb. N.	Part. N. Bestell N. Piece N. Pieza N.	Qt. Anzahl	DESCRIZIONE	DESCRIPTION	DESCRIPTION	BENENNUNG	DESCRIPCION
●	923988-4-00	1	aspira catenella completa	chain suction assembly	aspiration chafnette complète		
1	926323-2-01	1	piano di lavoro completo	working plate assembly	plan de travail complet		
2	923806-0-00	1	tubo	pipe	tube		
3	923979-2-00	1	tubo aspirazione	pipe	tube		
4	926757-4-01	1	gruppo coltelli	knives assembly	groupe couteaux		
5	926758-0-00	1	vite	screw	vis		
6	923918-0-01	1	molla	spring	ressort		
7	926756-2-01	1	coltello mobile	movable knife	couteau mobile		
8	926753-2-01	1	coltello fisso	immovable knife	couteau fixe		
9	923919-0-01	1	perno	pin	pivot		
10	744530-0-00	2	vite	screw	vis		
11	721410-0-00	1	vite	screw	vis		
12	746021-2-00	1	dado	nut	écrou		
13	704310-2-00	2	rondella	washer	rondelle		
14	923943-0-00	1	dado autobloccante	nut	écrou		
15	923942-0-00	1	perno filettato	pin	pivot		
16	923937-0-00	1	molla limitazione	spring	ressort		
17	745001-0-00	1	vite	screw	vis		
18	741974-2-00	1	vite	screw	vis		
19	923976-0-00	1	distanziale	spacer	entretoise		
20	923986-0-00	1	azionatore	actuator	activateur		
21	741931-0-00	1	vite	screw	vis		

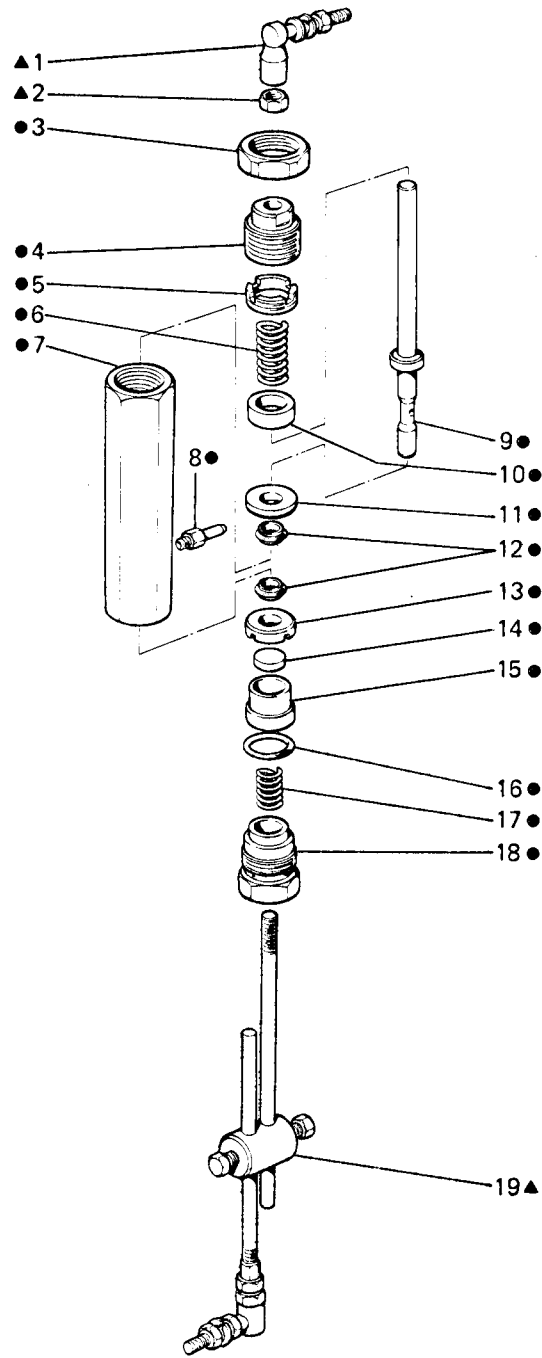

Fig. N. Abb. N.	Part. N. Piece N. Bestell N. Pieza N.	Qt. Anzahl	DESCRIZIONE	DESCRIPTION	DESCRIPTION	BENENNUNG	DESCRIPCION
▲●	923815-5-00	1	tirante completo	tie-rod assembly	tirant complet		
●	923816-4-00	1	valvola completa	valve assembly	soupape complète		
1	900942-0-00	1	snodo	knuckle	axe		
2	746203-4-00	1	dado	nut	écrou		
3	924796-0-10	1	dado	nut	écrou		
4	924790-0-10	1	tappo	plug	bouchon		
5	924800-0-11	1	ghiera	ring nut	collier		
6	203909-0-11	1	molla	spring	ressort		
7	923819-0-00	1	cilindro	cylinder	cyllindre		
8	924797-0-10	2	attacco	pipe union	raccord		
9	923818-0-00	1	pistone	piston	piston		
10	923825-0-00	1	distanziale	spacer	entretoise		
11	923822-0-00	1	rondella	washer	rondelle		
12	923828-4-00	2	anello di tenuta	retainer ring	bague d'étanchéité		
13	923823-0-00	1	rondella	washer	rondelle		
14	923821-0-00	1	pastiglia	plug	bouchon		
15	923820-0-00	1	distanziale	spacer	entretoise		
16	701017-0-00	1	anello di tenuta	retainer ring	bague d'étanchéité		
17	923826-0-00	1	molla	spring	ressort		
18	923824-0-00	1	tappo	plug	bouchon		
19	923812-0-00	1	tirante	tie-rod	tirant		

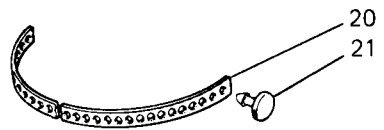
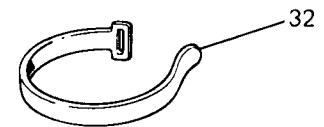
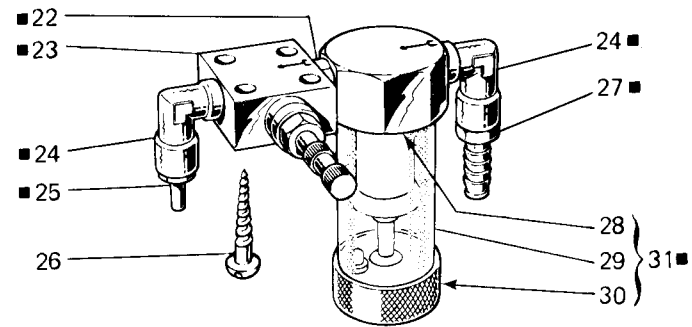
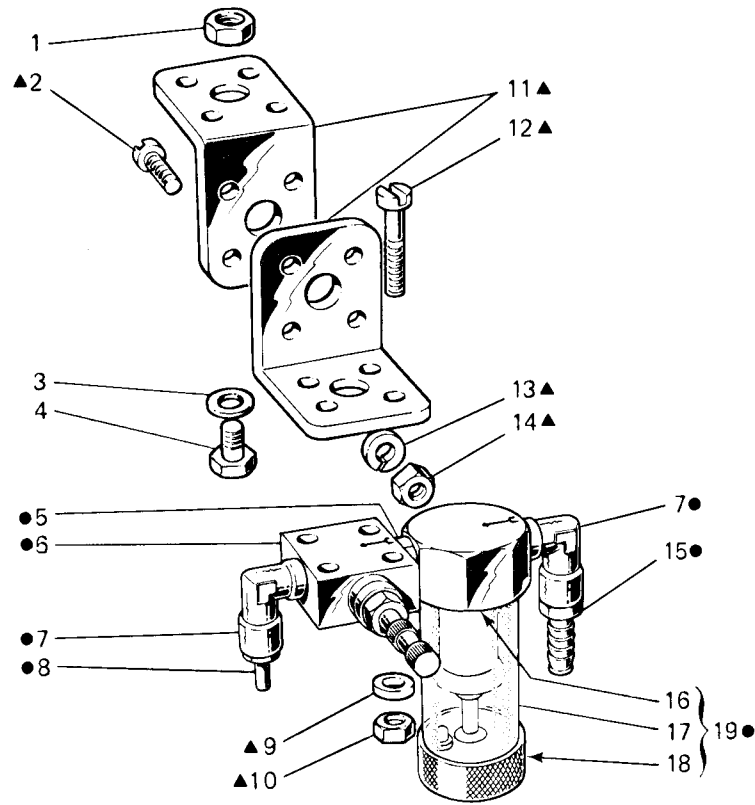

Fig. N. Abb. N.	Part. N. Bestell N. Piece N. Pieza N.	Qt. Anzahl	DESCRIZIONE	DESCRIPTION	DESCRIPTION	BENENNUNG	DESCRIPCION
			Solo per bancale regolabile	Only for adjustable stand	Seulement pour bâti réglable		
●▲	923958-4-00	1	gruppo dosatore-filtro	filter and dosimeter assembly	groupe doseur-filtre		
●	923805-4-01	1	gruppo filtro	filter assembly	groupe filtre		
1	902272-0-00	1	dado	nut	écrou		
2	721484-2-00	4	vite	screw	vis		
3	704011-4-00	1	rondella	washer	rondelle		
4	720485-4-00	1	vite	screw	vis		
5	923802-0-00	1	nipplo	nipple	raccord à vis		
6	923800-0-00	1	dosatore	dosimeter	doseur		
7	923803-0-00	2	raccordo	pipe-connection	raccord		
8	924870-0-10	1	attacco	pipe union	raccord		
9	704306-2-00	2	rondella	washer	rondelle		
10	746007-2-00	2	dado	nut	écrou		
11	925513-0-00	2	squadretta	bracket	équerre		
12	741082-2-00	2	vite	screw	vis		
13	703005-0-00	4	rondella	washer	rondelle		
14	733505-2-00	4	dado	nut	écrou		
15	923804-0-00	1	attacco	pipe union	raccord		
16	924991-0-00	1	guarnizione	gasket	garniture		
17	924992-0-00	1	tazza	container	tasse		
18	924990-0-00	1	guarnizione	gasket	garniture		
19	923801-4-00	1	filtro aria completo	air filter assembly	filtre aire complet		
20	990441-0-10	2	cinturino	strap	bride		
21	990442-0-10	2	bottoncino	button	bouton		
			Solo per bancale a colonna	Only for column stand	Seulement pour bâti a colonne		
■	923805-4-01	1	gruppo filtro	filter assembly	groupe filtre		
22	923802-0-00	1	nipplo	nipple	raccord à vis		
23	923800-0-00	1	dosatore	dosimeter	doseur		
24	923803-0-00	2	raccordo	pipe connection	raccord		
25	924870-0-10	1	attacco	pipe union	raccord		
26	731105-0-00	4	vite	screw	vis		
27	923804-0-00	1	attacco	pipe union	raccord		
28	924991-0-00	1	guarnizione	gasket	garniture		
29	924992-0-00	1	tazza	container	tasse		
30	924990-0-00	1	guarnizione	gasket	garniture		
31	923801-4-00	1	filtro aria completo	air filter assembly	filtre aire complet		
32	920258-0-10	1	cinturino	strap	bride		

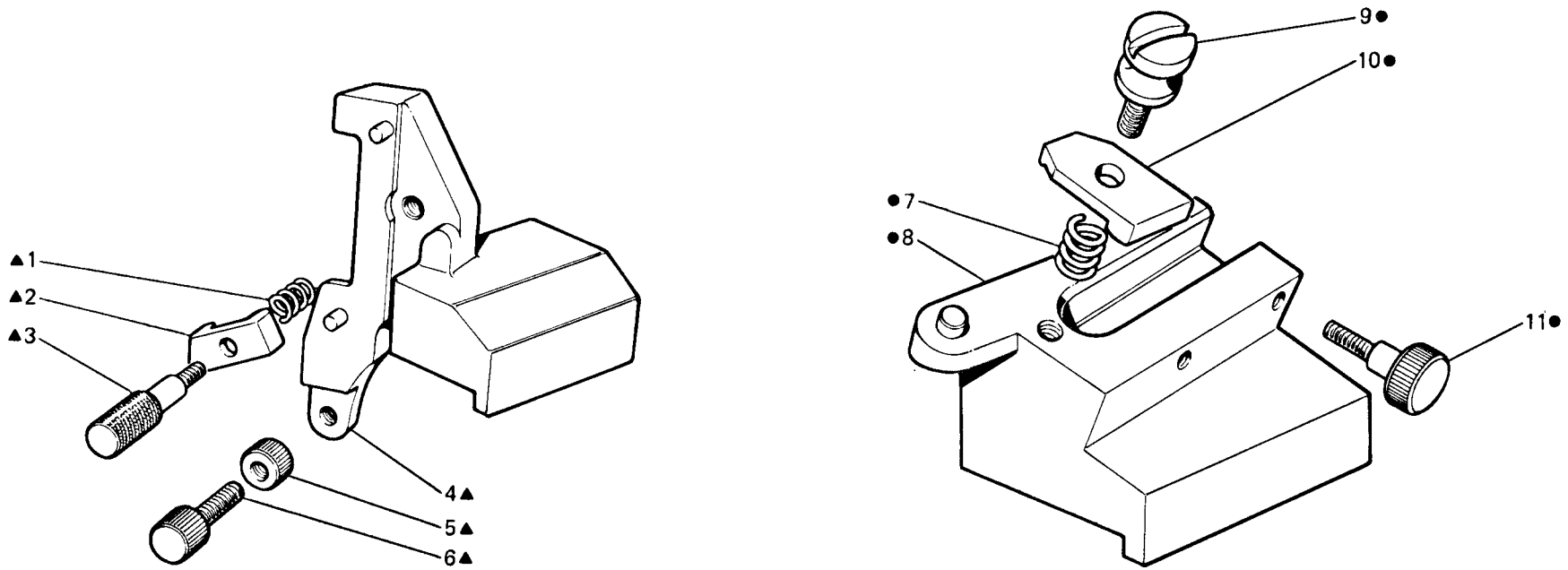

Fig. N. Abb. N.	Part. N. Bestell N. Piece N. Pieza N.	Qt. Anzahl	DESCRIZIONE	DESCRIPTION	DESCRIPTION	BENENNUNG	DESCRIPCION
			SOLO A RICHIESTA	ONLY ON REQUEST	SEULEMENT SUR DEMANDE		
▲	990654-4-00	1	affila coltelli completo (coltello fisso)	sharpener assembly (immovable knife)	affûteuse complète (couteau fixe)		
●	990630-4-00	1	affila coltelli completo (coltello mobile)	sharpener assembly (movable knife)	affûteuse complète (couteau mobile)		
1	990669-0-00	1	molla	spring	ressort		
2	990668-0-00	1	staffa	bracket	bride		
3	990659-0-00	1	pomolo	knob	pommeau		
4	990658-2-00	1	blocchetto	block	bloc		
5	991016-0-00	1	ghiera	ring nut	collier		
6	991015-0-00	1	pomolo	knob	pommeau		
7	301561-0-10	1	molla	spring	ressort		
8	990634-2-00	1	blocchetto	block	bloc		
9	300917-0-10	1	pomolo	knob	pommeau		
10	990633-0-00	1	staffa	bracket	bride		
11	990504-0-00	1	pomolo	knob	pommeau		

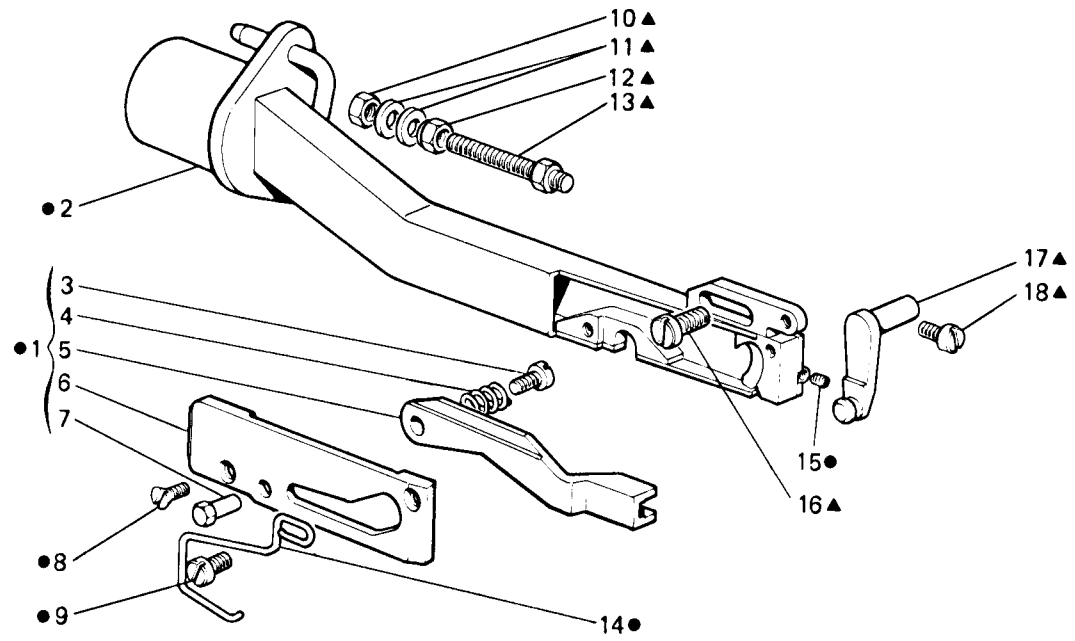
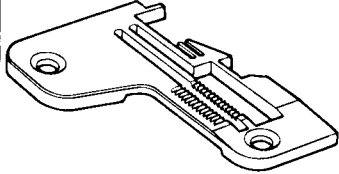
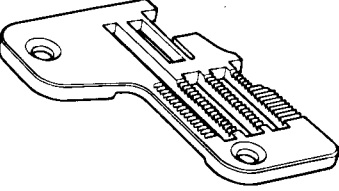
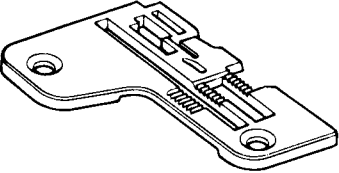
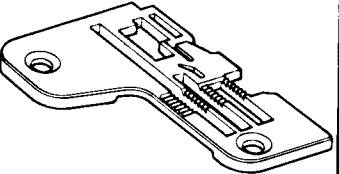
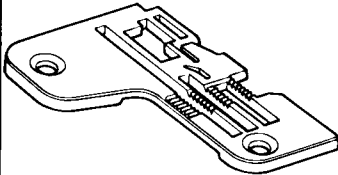
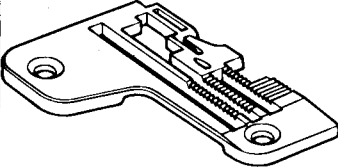
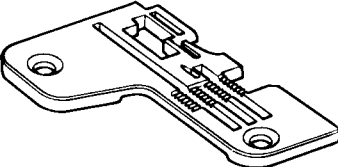
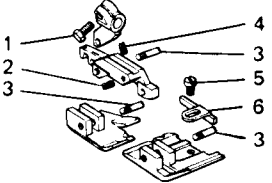

Fig. N. Abb. N.	Part. N. Bestell N. Pieza N.	Qt. Anzahl	DESCRIZIONE	DESCRIPTION	DESCRIPTION	BENENNUNG	DESCRIPCION
			SOLO A RICHIESTA	ONLY ON REQUEST	SEULEMENT SUR DEMANDE		
●▲	923987-5-00	1	gruppo aspira catenella	chain suction assembly	groupe aspiration chaînette		
●	923988-4-00	1	aspira catenella completa	chain suction assembly	aspiration chaînette complète		
1	926757-4-01	1	gruppo coltelli	knives assembly	groupe couteaux		
2	923979-2-00	1	tubo aspirazione	suction pipe	tube aspirateur		
3	926758-0-00	1	vite	screw	vis		
4	923918-0-01	1	molla	spring	ressort		
5	926756-2-01	1	coltello mobile	movable knife	couteau mobile		
6	926753-2-01	1	coltello fisso	immovable knife	couteau fixe		
7	923919-0-01	1	perno	pin	pivot		
8	744530-0-00	2	vite	screw	vis		
9	721410-0-00	1	vite	screw	vis		
10	746021-2-00	1	dado	nut	écrou		
11	704310-2-00	2	rondella	washer	rondelle		
12	923943-0-00	1	dado	nut	écrou		
13	923942-0-00	1	perno filettato	pin	pivot		
14	923937-0-00	1	molla limitazione	spring	ressort		
15	745001-0-00	1	vite	screw	vis		
16	741974-2-00	1	vite	screw	vis		
17	923986-0-00	1	azionatore	actuator	activateur		
18	741931-0-00	1	vite	screw	vis		

TAV. 6

PER TESTA FOR HEAD POUR TETE FUER OBERTEIL			IN DOTAZIONE - EQUIPMENT - EN DOTATION - NORMALAUESRUSTUNG				A RICHIESTA - ON REQUEST - SUR DEMANDE - AUF ANFRAGE						
			PIEDINO PRESSER-FOOT PIED-PRESSEUR FUESSCHEN	PLACCA AGO NEEDLE PLATE PLAQUE A AIGUILLE STICHPLATTE	GRIFFA FEED DOG GRIFFE TRANSPORTEUR	GRIFFINO FEED DOG GRIFFE TRANSPORTEUR	PIEDINO PRESSER-FOOT PIED-PRESSEUR FUESSCHEN	PLACCA AGO NEEDLE PLATE PLAQUE A AIGUILLE STICHPLATTE					
527-01-2CD-20				 926797-0-01									
527-49-1MD-01				 926830-0-00									
529-00-2CD-01											 204809-0-02		
529-00-2CD-05											 204948-0-12		
Fig. N. Abb. N.	Part. N. Piec N. Bestell N.	Qt. Anzahl	DESCRIZIONE DESCRIPTION		Fig. N. Abb. N.	Part. N. Piec N. Bestell N.	Qt. Anzahl	DESCRIZIONE DESCRIPTION					

PER TESTA FOR HEAD POUR TETE FUER OBERTEIL			IN DOTAZIONE - EQUIPMENT - EN DOTATION - NORMALAUESRUSTUNG				A RICHIESTA - ON REQUEST - SUR DEMANDE - AUF ANFRAGE			
			PIEDINO PRESSER-FOOT PIED-PRESSEUR FUESSCHEN	PLACCA AGO NEEDLE PLATE PLAQUE A AIGUILLE STICHPLATTE	GRIFFA FEED DOG GRIFFE TRANSPORTEUR	GRIFFINO FEED DOG GRIFFE TRANSPORTEUR	PIEDINO PRESSER-FOOT PIED-PRESSEUR FUESSCHEN	PLACCA AGO NEEDLE PLATE PLAQUE A AIGUILLE STICHPLATTE		
529-00-2CD-12										204948-0-12
529-00-2CD-15									926829-0-00	
529-00-2MD-06									207051-0-01	
529-00-2MS-07										
			925553-3-00							
Fig. N. Abb. N.	Part. N. Piece N. Bestell N.	Qt. Anzahl	DESCRIZIONE	DESCRIPTION	Fig. N. Abb. N.	Part. N. Piece N. Bestell N.	Qt. Anzahl	DESCRIZIONE	DESCRIPTION	
1	204947-0-10	1	vite	screw						
2	745001-0-00	1	vite	screw						
3	204869-0-11	3	vite	screw						
4	727021-0-00	1	vite	screw						
5	741413-2-00	1	vite	screw						
6	206982-0-01	1	piastrina	plate						

TAV. 8

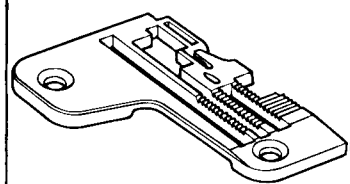
PER TESTA FOR HEAD POUR TETE FUER OBERTEIL			IN DOTAZIONE – EQUIPMENT – EN DOTATION – NORMALAUESRUSTUNG				A RICHIESTA - ON REQUEST - SUR DEMANDE - AUF ANFRAGE						
			PIEDINO PRESSER-FOOT PIED-PRESSEUR FUSSCHEN		PLACCA AGO NEEDLE PLATE PLAQUE A AIGUILLE STICHPLATTE		GRIFFA FEED DOG GRIFFE TRANSPORTEUR		GRIFFINO FEED DOG GRIFFE TRANSPORTEUR		PIEDINO PRESSER-FOOT PIED-PRESSEUR FUSSCHEN		PLACCA AGO NEEDLE PLATE PLAQUE A AIGUILLE STICHPLATTE
529-22-2CD-03										 926829-0-00			
Fig. N. Abb. N.	Part. N. Piece N. Bestell N.	Qt. Anzahl	DESCRIZIONE DESCRIPTION				Fig. N. Abb. N.	Part. N. Piece N. Bestell N.	Qt. Anzahl	DESCRIZIONE DESCRIPTION			

APPARECCHIATURA ATTACHMENT DISPOSITIF VORRICHTUNG

137-81

PER TESTE	527-00-1CD-09
FOR HEADS	527-00-1CD-39
POUR TETES	527-00-2CD-12
FUER OBERTEILE	527-00-2CD-13
	527-00-2CD-38
	527-00-2CD-44

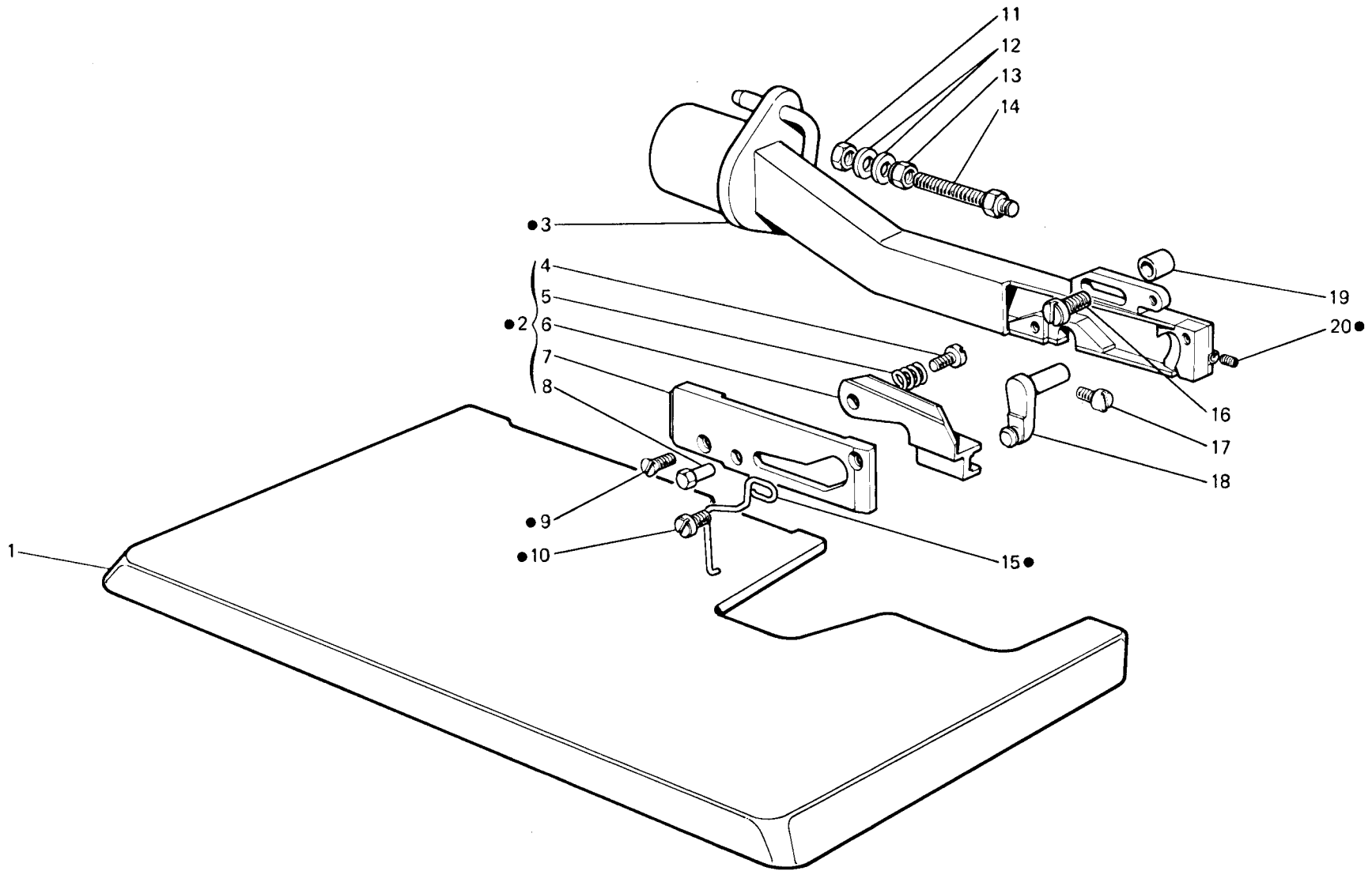

Fig. N. Abb. N.	Part. N. Bestell N. Piece N. Pieza N.	Qt. Anzahl	DESCRIZIONE	DESCRIPTION	DESCRIPTION	BENENNUNG	DESCRIPCION
●	923989-4-00	1	aspira catenella completa	chain suction assembly	aspiration chaînette complète		
1	926323-2-01	1	piano di lavoro completo	working plate assembly	plan de travail complet		
2	926755-4-01	1	gruppo coltelli	knives assembly	groupe couteaux		
3	923978-2-00	1	tubo aspirazione	pipe	tube		
4	926758-0-00	1	vite	screw	vis		
5	923918-0-01	1	molla	spring	ressort		
6	926754-2-01	1	coltello mobile	movable knife	couteau mobile		
7	926753-2-01	1	coltello fisso	immovable knife	couteau fixe		
8	923919-0-01	1	perno	pin	pivot		
9	744530-0-00	2	vite	screw	vis		
10	721410-0-00	1	vite	screw	vis		
11	746021-2-00	1	dado	nut	écrou		
12	704310-2-00	2	rondella	washer	rondelle		
13	923943-0-00	1	dado autobloccante	nut	écrou		
14	923942-0-00	1	perno filettato	pin	pivot		
15	923936-0-01	1	molla limitazione	spring	ressort		
16	741974-2-00	1	vite	screw	vis		
17	741931-0-00	1	vite	screw	vis		
18	923985-0-00	1	azionatore	actuator	activateur		
19	923976-0-00	1	distanziale	spacer	entretoise		
20	745001-0-00	1	vite	screw	vis		

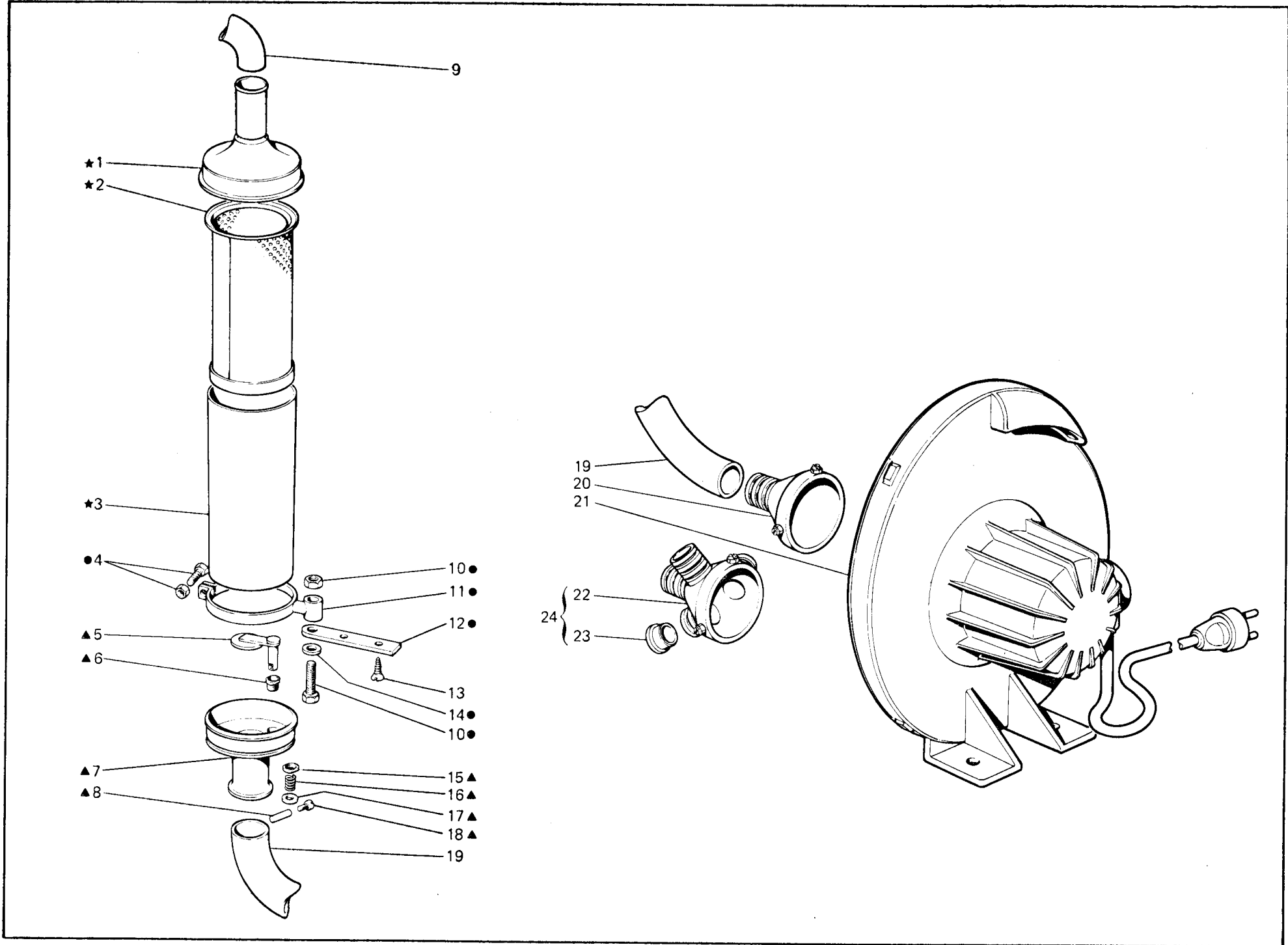

Fig. N. Abb. N.	Part. N. Piece N. Bestell N. Pieza N.	Qt. Anzahl	DESCRIZIONE	DESCRIPTION	DESCRIPTION	BENENNUNG	DESCRIPCION
★▲	921271-4-10	1	filtro aria completo	air filter assembly			
●	921285-4-10	1	sostegno completo	support assembly	filtre aire compl.		
▲	921270-4-10	1	bocchettone inferiore completo	lower cup assembly	support complet		
1	921282-0-10	1	bocchettone superiore	upper cup	embouchure inférieur complet		
2	921279-2-10	1	corpo centrale	central body	embouchure supérieur		
3	921281-0-10	1	corpo filtro	filter body	corps central		
4	921331-0-10	1	bullone	bolt	corps filtre		
5	921274-2-10	1	leva a forcella	lever	boulon		
6	921291-0-10	1	boccola	bearing	levier		
7	921269-2-10	1	bocchettone inferiore	lower cup	roulement		
8	921289-0-10	1	astina	rod	embouchure inférieur		
9	921293-0-10	1	tubo	pipe	tige		
10	921330-0-10	1	bullone	bolt	tube		
11	921284-2-10	1	fascia	clamp	boulon		
12	921288-0-10	1	attacco	attachment	bride		
13	731066-0-00	2	vite	screw	raccord		
14	704011-0-00	1	rondella	washer	vis		
15	921292-0-10	1	ghiera	ring nut	rondelle		
16	921290-0-10	1	molla	spring	collier		
17	704314-0-00	1	rondella	washer	ressort		
18	741682-0-00	1	vite	screw	rondelle		
19	921294-0-10	1	tubo	pipe	vis		
20	921298-0-10	1	bocchettone a 1 via	cup	tube		
21	921300-0-10	1	elettroaspiratore monofase 125V 50 Hz 370 W	single-phase electroaspirator 125V - 50 Hz - 370W	embouchure aspirateur électrique 125V - 50 Hz - 370W		
			SOLO A RICHIESTA	ONLY ON REQUEST	SEULEMENT SUR DEMANDE		
19	921295-0-10	1	tubo (collegamento 2 macchine)	pipe			
-	921296-0-10	1	tubo (collegamento 3 macchine)	pipe	tube		
-	921297-0-10	1	tubo (collegamento 4 macchine)	pipe	tube		
21	921301-0-10	1	elettroaspiratore monofase 220V - 50 Hz - 370W	single-phase electroaspirator 220V - 50 Hz - 370W	aspirateur électrique 220V - 50 Hz - 370W		
-	921303-0-10	1	elettroaspiratore trifase 220V - 50Hz - 370W	three-phase electroaspirator 220V - 50Hz - 370W	aspirateur électrique 220V - 50Hz - 370W		
-	921304-0-10	1	elettroaspiratore trifase 240/415V - 50Hz - 370W	three-phase electroaspirator 240/415V - 50Hz - 370W	aspirateur électrique 240/415V - 50Hz - 370W		
-	921306-0-10	1	elettroaspiratore monofase 110V - 60Hz - 370W	single-phase electroaspirator 110V - 60Hz - 370W	aspirateur électrique 110V - 60Hz - 370W		
-	921307-0-10	1	elettroaspiratore monofase 220V - 60Hz - 370W	single-phase electroaspirator 220V - 60Hz - 370W	aspirateur électrique 220V - 60Hz - 370W		
-	921309-0-10	1	elettroaspiratore trifase 110/200V - 60Hz - 370W	three-phase electroaspirator 110/200V - 60Hz - 370W	aspirateur électrique 110/200V - 60Hz - 370W		
-	921310-0-10	1	elettroaspiratore trifase 220/380V - 60Hz - 370W	three-phase electroaspirator 220/380V - 60Hz - 370W	aspirateur électrique 220/380V - 60Hz - 370W		
22	921312-0-10	1	bocchettone 4 vie	cup	embouchure		
23	921327-0-11	3	tappo	plug	bouchon		
24	921313-4-10	1	bocchettone 4 vie completo	cup assembly	embouchure complet		

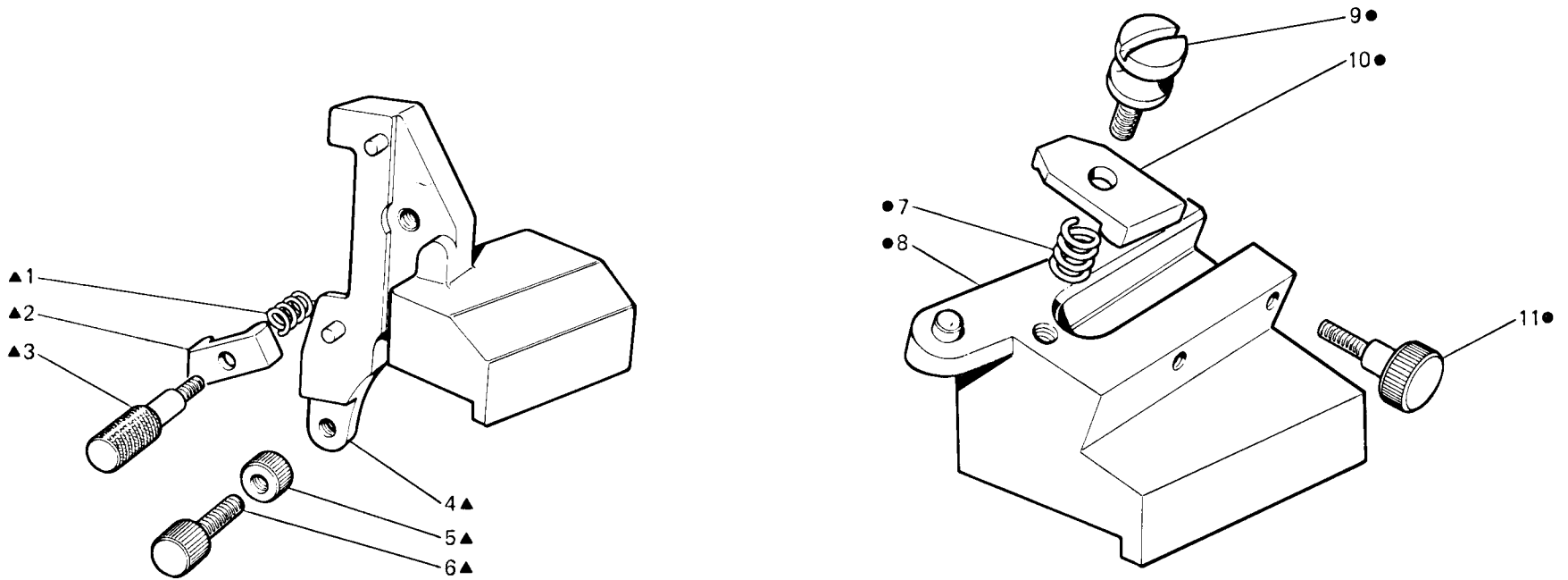
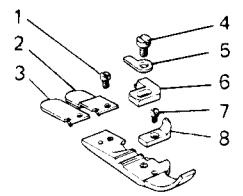
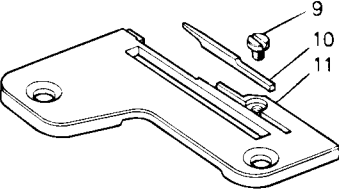
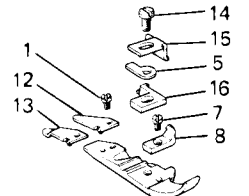
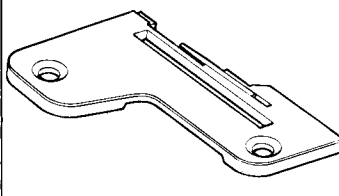
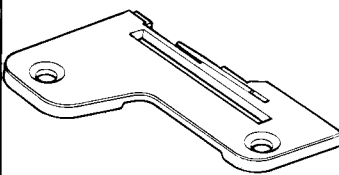
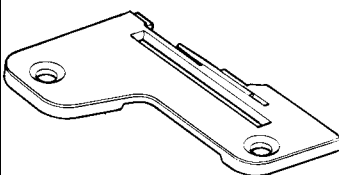
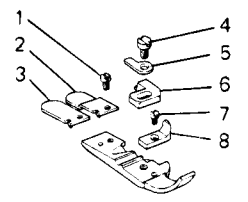
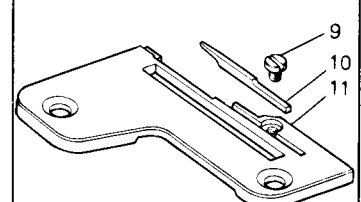
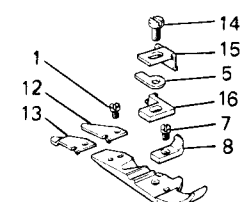
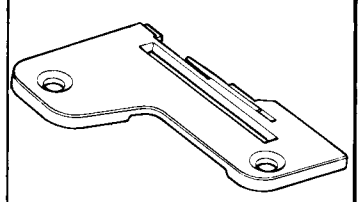
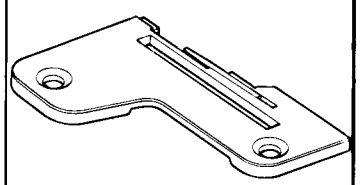
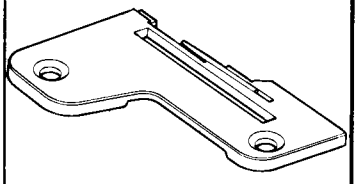

Fig. N. Abb. N.	Part. N. Bestell N. Pieze N. Pieza N.	Qt. Anzahl	DESCRIZIONE	DESCRIPTION	DESCRIPTION	BENENNUNG	DESCRIPCION
			SOLO A RICHIESTA	ONLY ON REQUEST	SEULEMENT SUR DEMANDE		
▲	990654-4.00	1	affila coltelli completo (coltello fisso)	sharpener assembly (immovable knife)	affûteuse complète (couteau fixe)		
●	990630-4.00	1	affila coltelli completo (coltello mobile)	sharpener assembly (movable knife)	affûteuse complète (couteau mobile)		
1	990669-0.00	1	molla	spring	ressort		
2	990668-0.00	1	staffa	bracket	bride		
3	990659-0.00	1	pomoio	knob	pommeau		
4	990658-2.00	1	bloccetto	block	bloc		
5	991016-0.00	1	ghiera	ring nut	collier		
6	991015-0.00	1	pomoio	knob	pommeau		
7	301561-0.10	1	molla	spring	ressort		
8	990634-2.00	1	bloccetto	block	bloc		
9	300917-0.10	1	pomoio	knob	pommeau		
10	990633-0.00	1	staffa	bracket	bride		
11	990504-0.00	1	pomoio	knob	pommeau		



TAV. 4

PER TESTA FOR HEAD POUR TETE FUER OBERTEIL		IN DOTAZIONE - EQUIPMENT - EN DOTATION - NORMALAUESRUSTUNG				A RICHIESTA - ON REQUEST - SUR DEMANDE - AUF ANFRAGE							
		PIEDINO PRESSER FOOT PIED PRESSEUR FUSSCHEN		PLACCA AGO NEEDLE PLATE PLAQUE A AIGUILLE STICHPLATTE		GRIFFA FEED DOG GRIFFE TRANSPORTEUR		GRIFFINO FEED DOG GRIFFE TRANSPORTEUR		PIEDINO PRESSER FOOT PIED PRESSEUR FUSSCHEN		PLACCA AGO NEEDLE PLATE PLAQUE A AIGUILLE STICHPLATTE	
527-00-1CD-09													
		926092-3-00		923211-4-00						923910-3-01		923200-2-00	
													
													
												923202-2-00	
												923205-2-00	
Fig. N Abb. N	Part N Piece N Bestell. N	Qt Anzahl	DESCRIZIONE	DESCRIPTION	Fig. N Abb. N	Part N Piece N Bestell. N	Qt Anzahl	DESCRIZIONE	DESCRIPTION				
1	741413-2-00	2	vite	screw	11	923210-0-00	1	placca ago	needle plate				
2	921448-0-10	1	piastrina	plate	12	921515-0-00	1	piastrina	plate				
3	921444-0-10	1	piastrina	plate	13	921532-0-10	1	piastrina	plate				
4	741665-2-00	1	vite	screw	14	741675-2-00	1	vite	screw				
5	202201-0-11	2	staffa	bracket	15	203483-0-11	1	piastrina	plate				
6	203377-0-11	1	linguetta	tongue	16	203378-0-11	1	linguetta	tongue				
7	741431-2-00	2	vite	screw									
8	202184-0-11	2	blocchetto	block									
9	203382-0-10	1	vite	screw									
10	203357-0-10	1	linguetta	tongue									

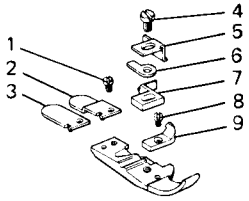
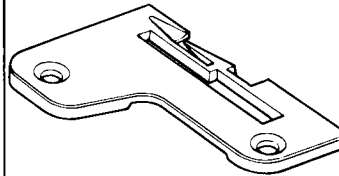
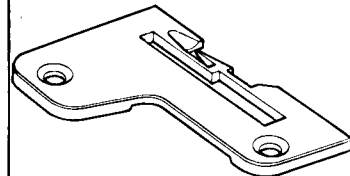
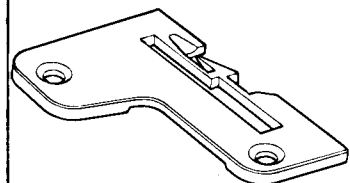

PER TESTA FOR HEAD POUR TETE FUER OBERTEIL		IN DOTAZIONE - EQUIPMENT - EN DOTATION - NORMALAUESRUSTUNG				A RICHIESTA - ON REQUEST - SUR DEMANDE - AUF ANFRAGE							
		PIEDINO PRESSER-FOOT PIED-PRESSEUR FUESSCHEN		PLACCA AGO NEEDLE PLATE PLAQUE A AIGUILLE STICHPLATTE		GRIFFA FEED DOG GRIFFE TRANPORTEUR		GRIFFINO FEED DOG GRIFFE TRANPORTEUR		PIEDINO PRESSER-FOOT PIED-PRESSEUR FUESSCHEN		PLACCA AGO NEEDLE PLATE PLAQUE A AIGUILLE STICHPLATTE	
527-00-1CD-39													
		926092-3-00		923211-4-00						923910-3-01		923200-2-00	
													
													
												923205-2-00	
Fig. N. Abb. N.	Part. N. Piece N. Bestell N.	Qt. Anzahl	DESCRIZIONE	DESCRIPTION	Fig. N. Abb. N.	Part. N. Piece N. Bestell N.	Qt. Anzahl	DESCRIZIONE	DESCRIPTION				
1	741413-2-00	2	vite	screw	11	923210-0-00	1	placca ago	needle plate				
2	921448-0-10	1	piastrina	plate	12	921515-0-00	1	piastrina	plate				
3	921444-0-10	1	piastrina	plate	13	921532-0-10	1	piastrina	plate				
4	741665-2-00	1	vite	screw	14	741675-2-00	1	vite	screw				
5	202201-0-11	2	staffa	bracket	15	203483-0-11	1	piastrina	plate				
6	203377-0-11	1	linguetta	tongue	16	203378-0-11	1	linguetta	tongue				
7	741431-2-00	2	vite	screw									
8	202184-0-11	2	blocchetto	block									
9	203382-0-10	1	vite	screw									
10	203357-0-10	1	linguetta	tongue									

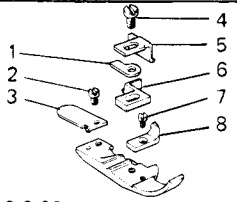
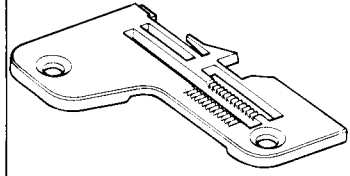
TAV. 6

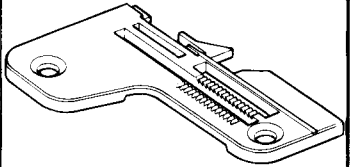
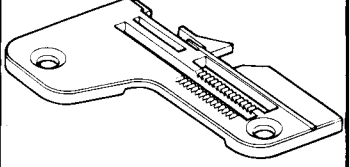
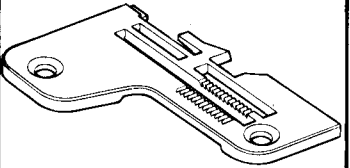
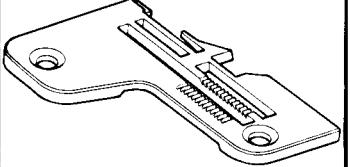
PER TESTA FOR HEAD POUR TETE FUER OBERTEIL		IN DOTAZIONE – EQUIPMENT – EN DOTATION – NORMALAUESRUSTUNG				A RICHIESTA - ON REQUEST - SUR DEMANDE - AUF ANFRAGE			
		PIEDINO PRESSER-FOOT PIED-PRESSEUR FUESSCHEN	PLACCA AGO NEEDLE PLATE PLAQUE A AIGUILLE STICHPLATTE	GRIFFA FEED DOG GRIFFE TRANSPORTEUR	GRIFFINO FEED DOG GRIFFE TRANSPORTEUR	PIEDINO PRESSER-FOOT PIED-PRESSEUR FUESSCHEN	PLACCA AGO NEEDLE PLATE PLAQUE A AIGUILLE STICHPLATTE		
527-00-2CD-12									
							926089-3-00	923194-0-00	
									
							923193-0-00		
Fig. N. Abb. N.	Part. N. Pierce N. Bestell N.	Qt. Anzahl	DESCRIZIONE	DESCRIPTION	Fig. N. Abb. N.	Part. N. Pierce N. Bestell N.	Qt. Anzahl	DESCRIZIONE	DESCRIPTION
1	741413-2-00	1	vite	screw					
2	921459-0-10	1	piastrina	plate					
3	921444-0-10	1	piastrina	plate					
4	741675-2-00	1	vite	screw					
5	203483-0-11	1	piastrina	plate					
6	202201-0-11	1	staffa	bracket					
7	203453-0-11	1	linguetta	tongue					
8	741431-2-00	1	vite	screw					
9	202184-0-11	1	blocchetto	block					

PER TESTA FOR HEAD POUR TETE FUER OBERTEIL		IN DOTAZIONE – EQUIPMENT – EN DOTATION – NORMALAUESRUSTUNG				A RICHIESTA - ON REQUEST - SUR DEMANDE - AUF ANFRAGE			
		PIEDINO PRESSER-FOOT PIED-PRESSEUR FUSSCHEN	PLACCA AGO NEEDLE PLATE PLAQUE A AIGUILLE STICHPLATTE	GRIFFA FEED DOG GRIFFE TRANSPORTEUR	GRIFFINO FEED DOG GRIFFE TRANSPORTEUR	PIEDINO PRESSER-FOOT PIED-PRESSEUR FUSSCHEN	PLACCA AGO NEEDLE PLATE PLAQUE A AIGUILLE STICHPLATTE		
527-00-2CD-13									
		926090-3-00	923216-0-00		926093-0-00		923207-2-00		
									
							923209-2-00		
									
					923217-0-00				
									
					923239-0-00				
Fig. N. Abb. N.	Part. N. Piece N. Bestell N.	Qt. Anzahl	DESCRIZIONE	DESCRIPTION	Fig. N. Abb. N.	Part. N. Piece N. Bestell N.	Qt. Anzahl	DESCRIZIONE	DESCRIPTION
1	202201-0-11	1	staffa	bracket					
2	741413-2-00	1	vite	screw					
3	921444-0-10	1	piastrina	plate					
4	741675-2-00	1	vite	screw					
5	203483-0-11	1	piastrina	plate					
6	203453-0-11	1	linguetta	tongue					
7	741431-2-00	1	vite	screw					
8	202184-0-11	1	blocchetto	block					

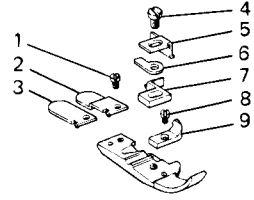
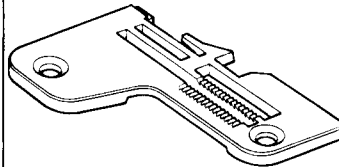
TAV. 8

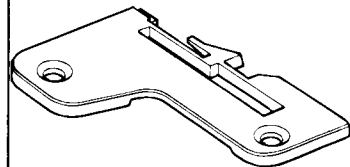
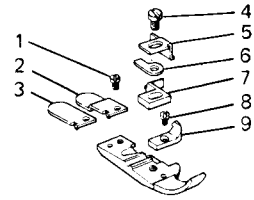
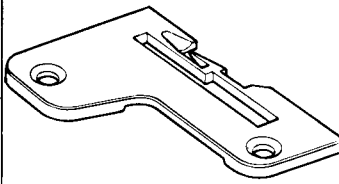
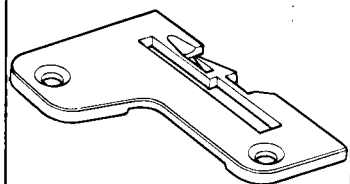
PER TESTA FOR HEAD POUR TETE FUER OBERTEIL		IN DOTAZIONE - EQUIPMENT - EN DOTATION - NORMALAUESRUSTUNG				A RICHIESTA - ON REQUEST - SUR DEMANDE - AUF ANFRAGE			
		PIEDINO PRESSER-FOOT PIED-PRESSEUR FUESSCHEN	PLACCA AGO NEEDLE PLATE PLAQUE A AIGUILLE STICHPLATTE	GRIFFA FEED DOG GRIFFE TRANSPORTEUR	GRIFFINO FEED DOG GRIFFE TRANSPORTEUR	PIEDINO PRESSER-FOOT PIED-PRESSEUR FUESSCHEN	PLACCA AGO NEEDLE PLATE PLAQUE A AIGUILLE STICHPLATTE		
527-00-2CD-38		 <p>926089-3-00</p>	 <p>923234-0-00</p>		 <p>926093-0-00</p>		 <p>923203-0-00</p>		
527-00-2CD-44		 <p>926089-3-00</p>	 <p>923191-0-00</p>				 <p>923193-0-00</p>		
Fig. N. Abb. N.	Part. N. Piec. N. Bestell N.	Qt. Anzahl	DESCRIZIONE	DESCRIPTION	Fig. N. Abb. N.	Part. N. Piec. N. Bestell N.	Qt. Anzahl	DESCRIZIONE	DESCRIPTION
1	741413-2-00	2	vite	screw					
2	921459-0-10	2	piastrina	plate					
3	921444-0-10	2	piastrina	plate					
4	741675-2-00	2	vite	screw					
5	203483-0-11	2	piastrina	plate					
6	202201-0-11	2	staffa	bracket					
7	203453-0-11	2	linguetta	tongue					
8	741431-2-00	2	vite	screw					
9	202184-0-11	2	blocchetto	block					