

Rimoldi

CATALOGO PEZZI DI RICAMBIO
SPARE PARTS CATALOGUE
CATALOGUE RECHANGES
ERSATZTEILELISTE

EPS-TPA / 1

n.231

652891070

UFFICIO CATALOGHI 3/80

CATALOGO PEZZI DI RICAMBIO
SPARE PARTS CATALOGUE
CATALOGUE RECHANGES
ERSATZTEILELISTE

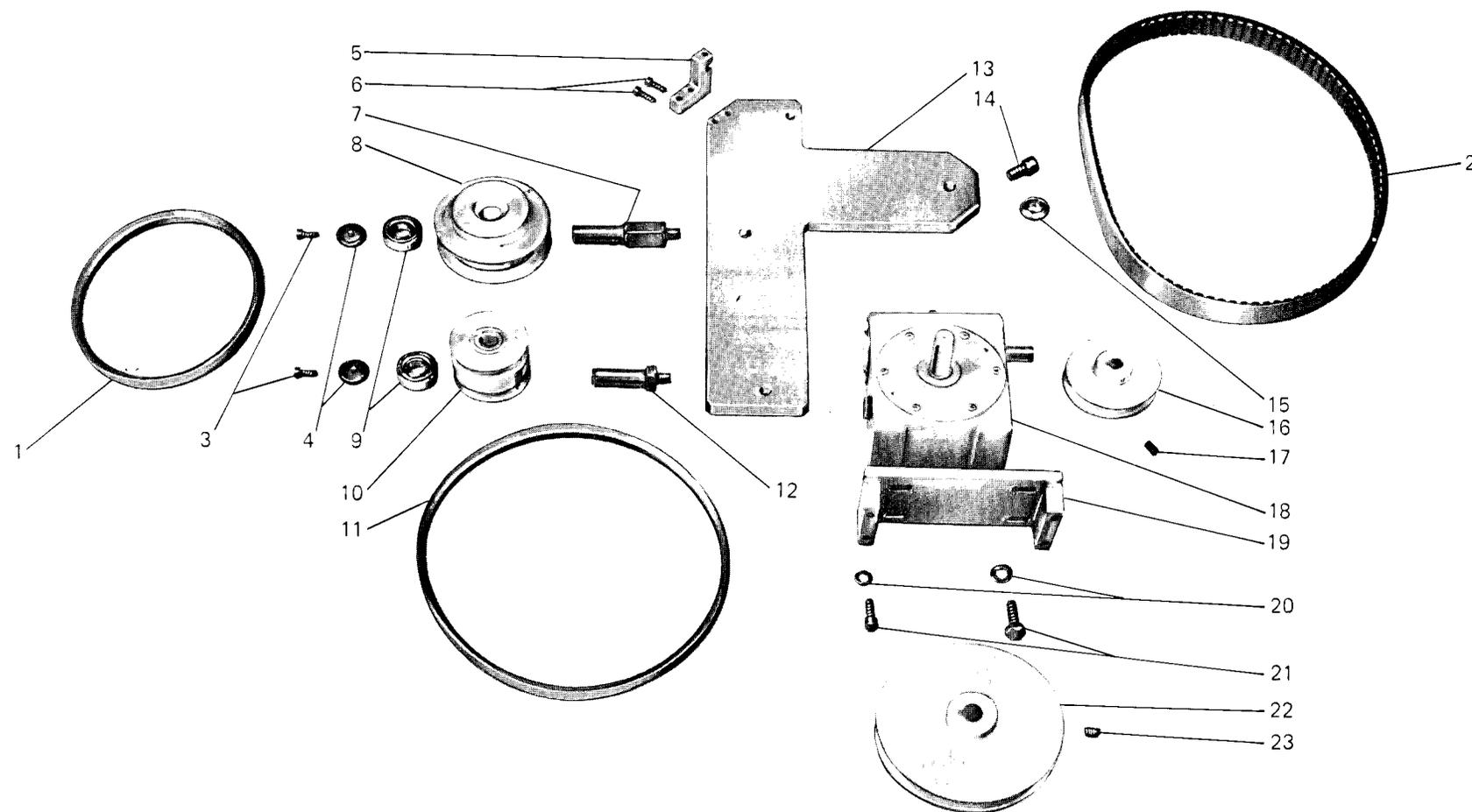

Fig. N. Abb. N.	Part. N. Bestell N. Pieze N.	Qt. Anzahl	DESCRIZIONE	DESCRIPTION	DESCRIPTION	BENENNUNG	DESCRIPCION
1	RPS-969/1	1	cinghia A 23	belt			
2	RPS-969/16	1	cinghia variatore 10x28x1120	belt			
3	RPS-969/01	2	vite	screw			
4	RPS-969/3	2	rondella	washer			
5	RPS-969/4	1	supporto	support			
6	RPS-969/02	2	vite	screw			
7	RPS-969/5	1	perno	pin			
8	RPS-969/6	1	puleggia variatore	pulley			
9	RPS-969/1A	2	cuscinetto	bearing			
10	RPS-969/7	1	puleggia comando riduttore	pulley			
11	RPS-969/8	1	cinghia A 34	belt			
12	RPS-969/9	1	perno	pin			
13	RPS-969/10	1	staffa	bracket			
14	RPS-969/03	1	vite	screw			
15	RPS-969/11	1	rondella	washer			
16	RPS-969/12	1	puleggia riduttore	pulley			
17	RPS-969/04	1	grano	screw			
18	RPS-969/13	1	riduttore	reduction unit			
19	RPS-969/14	1	supporto riduttore	support			
20	RPS-969/05	4	rondella	washer			
21	RPS-969/06	4	vite	screw			
22	RPS-969/15	1	puleggia comando macchina	pulley			
23	RPS-969/07	1	grano	screw			

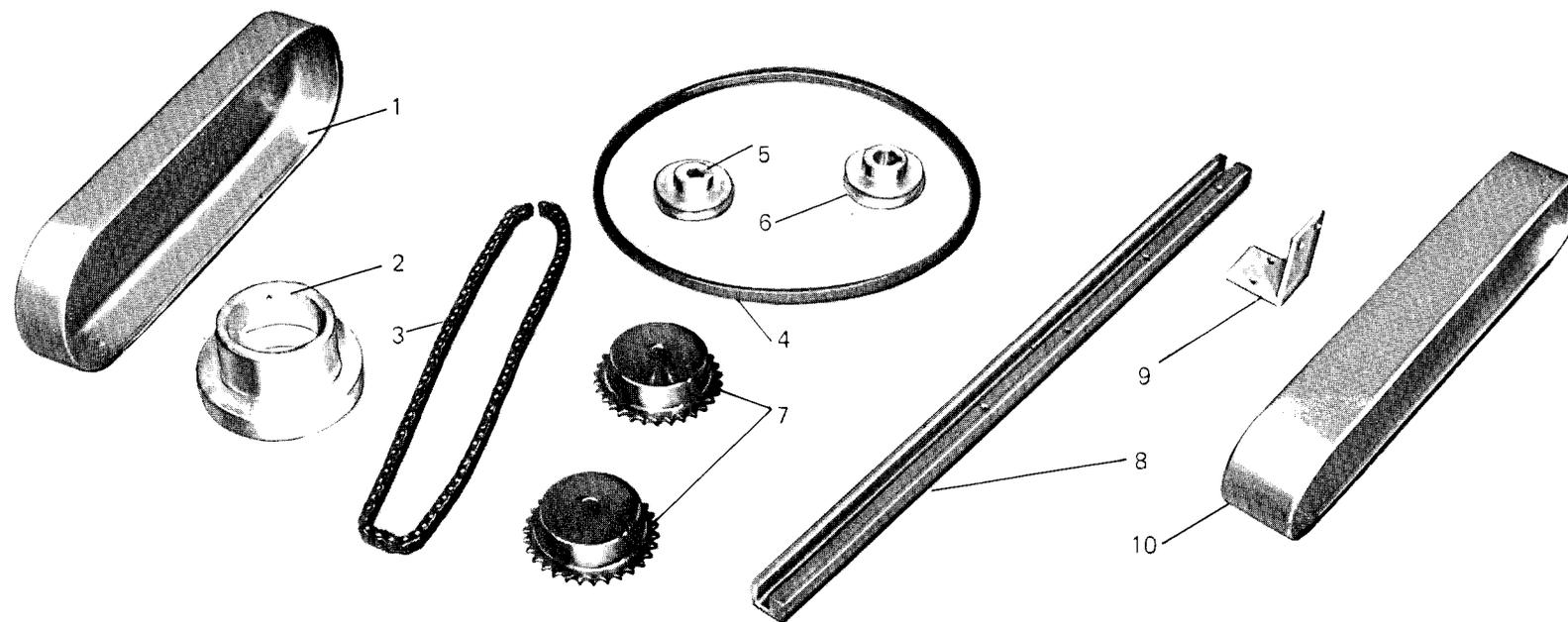

Fig. N. Abb. N.	Part. N. Bestell N. Piece N. Pieza N.	Qt. Anzahl	DESCRIZIONE	DESCRIPTION	DESCRIPTION	BENENNUNG	DESCRIPCION
1	RPS-969/300	1	carter copricatena	cover	carter		
2	RPS-969/301	1	supporto per carter	support	support		
3	RPS-969/302	1	catena com. rulli in gomma	chain	chainette		
4	RPS-969/303	1	cinghia Z comando ridutt. 1/40	belt	courroie		
5	RPS-969/304	1	puleggia comando ridutt. 1/40	pulley	poulie		
6	RPS-969/305	1	puleggia motore com. ridutt. 1/40	pulley	poulie		
7	RPS-969/306	2	ingranaggio Z30 P 3/8"	gear	engrenage		
8	RPS-969/307	1	slitta per carrello	slide	glissière		
9	RPS-969/308	1	squadretta di sostegno carter	bracket	équerre		
10	RPS-969/309	1	carter di protezione cinghia	cover	carter		

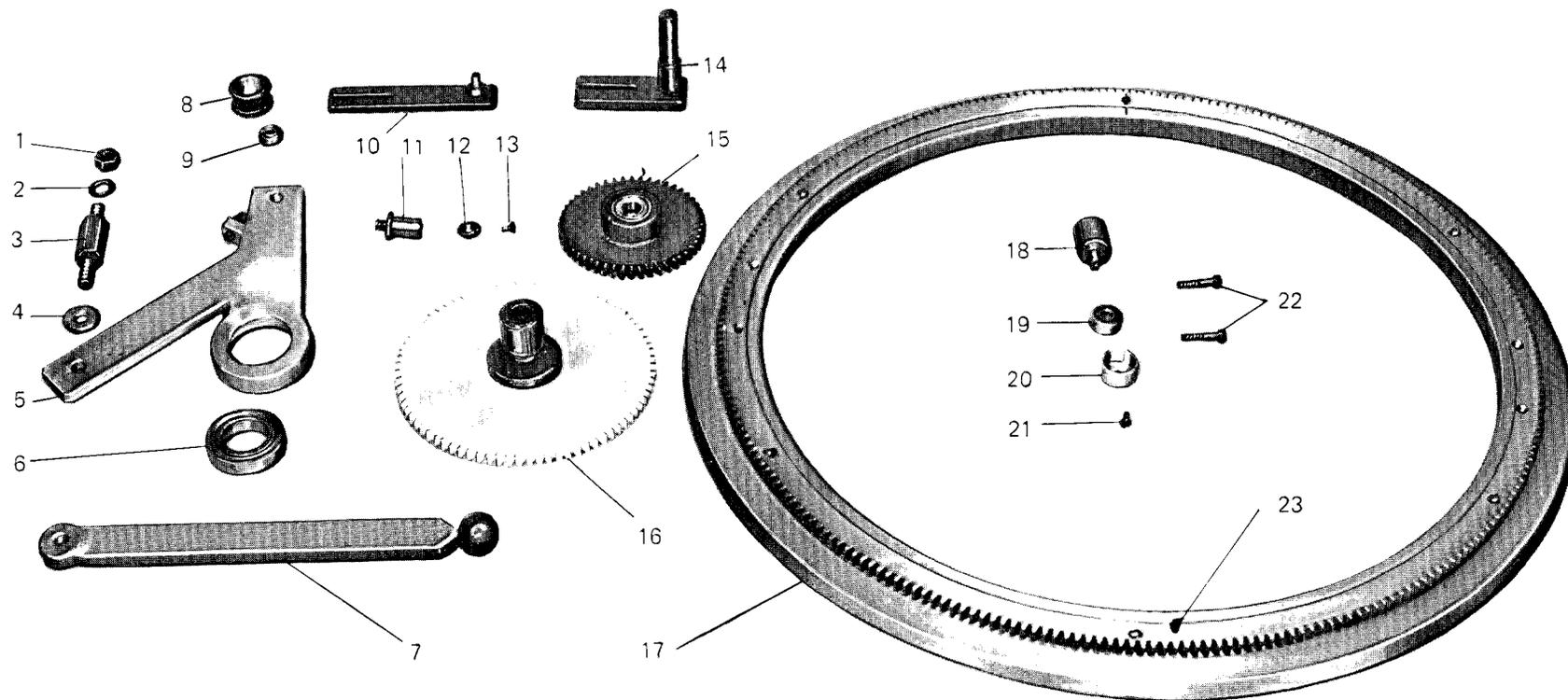

Fig. N. Abb. N.	Part. N. Piece N. Bestell N. Pieza N.	Qt. Anzahl	DESCRIZIONE	DESCRIPTION	DESCRIPTION	BENENNUNG	DESCRIPCION
1	RPS-969/010	1	dado 12M	nut	écrou		
2	RPS-969/011	1	rondella	washer	rondelle		
3	RPS-969/310	1	perno	pin	pivot		
4	RPS-969/311	1	distanziale	spacer	entretoise		
5	RPS-969/312	1	supporto	support	support		
6	RPS-969/313	1	cuscinetto 35x62x14 zz	bearing	coussinet		
7	RPS-969/314	1	maniglia di bloccaggio	lever	levier		
8	RPS-969/315	1	rullo tendicinghia	roller	rouleau		
9	RPS-969/316	1	cuscinetto 9x24x7 zz	bearing	coussinet		
10	RPS-969/317	1	supporto per tendicinghia	support	support		
11	RPS-969/318	1	perno	pin	pivot		
12	RPS-969/012	1	rondella Ø 20x3	washer	rondelle		
13	RPS-969/013	1	vite	screw	vis		
14	RPS-969/319	1	supporto con perno	support with pin	support avec pivot		
15	RPS-969/320	1	ingranaggio	gear	engrenage		
16	RPS-969/321	1	ingranaggio	gear	engrenage		
17	RPS-969/322	1	disco	disc	disque		
18	RPS-969/323	5	perno porta cuscinetto	pin	pivot		
19	RPS-969/324	5	cuscinetto 10x26x12 zz	bearing	coussinet		
20	RPS-969/325	5	copricuscinetto	bearing cover	couvre-coussinet		
21	RPS-969/013	5	vite	screw	vis		
22	RPS-969/014	4	vite	screw	vis		
23	RPS-969/326	1	corona dentata	crown	couronne		

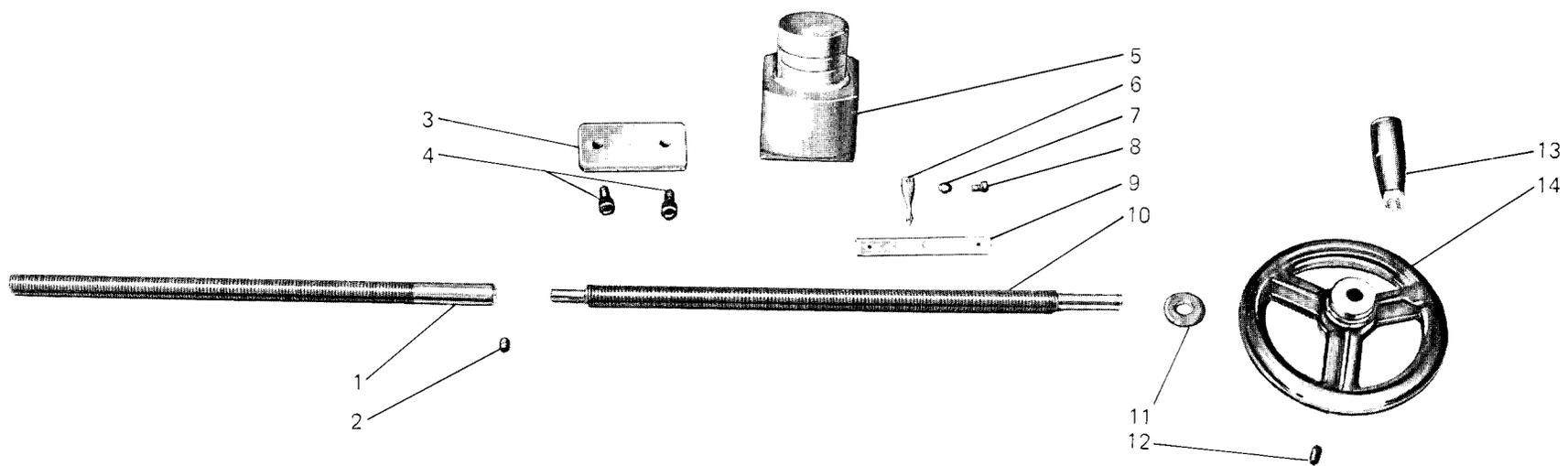

Fig. N. Abb. N.	Part. N. Piece N. Bestell N. Pieza N.	Qt. Anzahl	DESCRIZIONE	DESCRIPTION	DESCRIPTION	BENENNUNG	DESCRIPCION
1	RPS-969/26	1	vite sinistra	left screw	vis gauche		
2	RPS-969/013	2	grano	screw	vis		
3	RPS-969/27	1	staffa	bracket	bride		
4	RPS-969/014	2	vite	screw	vis		
5	RPS-969/28	2	supporto	support	support		
6	RPS-969/29	1	indice	index	indice		
7	RPS-969/015	1	rondella	washer	rondelle		
8	RPS-969/016	1	vite	screw	vis		
9	RPS-969/30	1	righello millimetrato	scale	règle		
10	RPS-969/31/1	1	vite destra	right screw	vis droite		
11	RPS-969/32	1	rondella	washer	rondelle		
12	RPS-969/017	1	grano	screw	vis		
13	RPS-969/33	1	maniglia	lever	levier		
14	RPS-969/34	1	volantino	handwheel	volant		

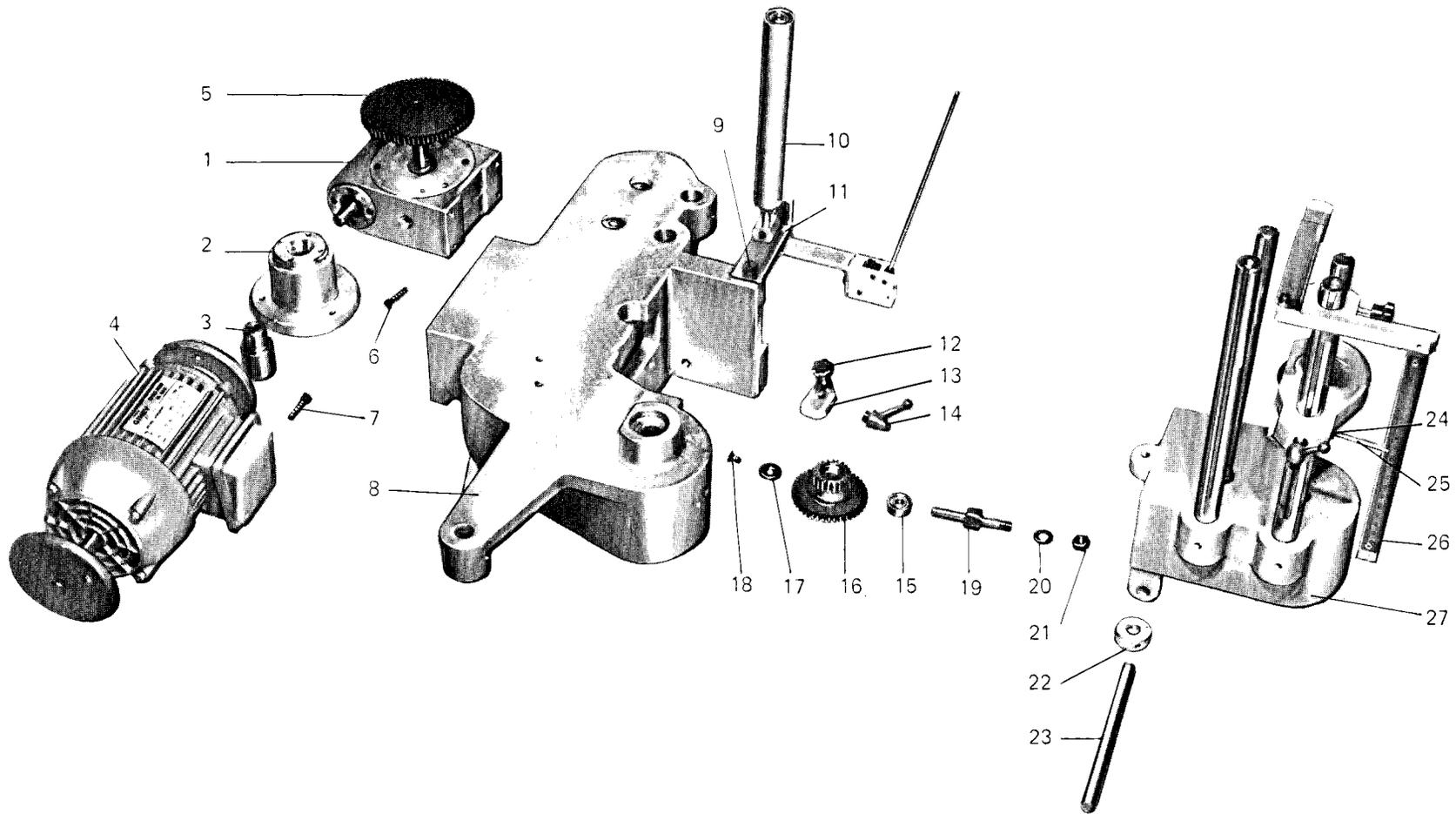

Fig. N. Abb. N.	Part. N. Piece N. Bestell N. Pieza N.	Qt. Anzahl	DESCRIZIONE	DESCRIPTION	DESCRIPTION	BENENNUNG	DESCRIPCION
1	RPS-969/327	1	riduttore	reduction unit	réducteur		
2	RPS-969/328	1	supporto motore	support	support		
3	RPS-969/329	1	giunto	joint	joint		
4	RPS-969/330	1	motore HP 010 V 220/380 50 Hz	motor	moteur		
5	RPS-969/331	1	ingranaggio	gear	engrenage		
6	RPS-969/015	4	vite	screw	vis		
7	RPS-969/016	3	vite	screw	vis		
8	RPS-969/332	1	supporto	support	support		
9	RPS-969/017	1	vite	screw	vis		
10	RPS-969/333	1	rullo	roller	rouleau		
11	RPS-969/334	1	staffa porta rullo	bracket	bride		
12	RPS-969/335	1	pomolo	knob	pommeau		
13	RPS-969/336	1	staffa di chiusura	bracket	bride		
14	RPS-969/337	1	maniglia	lever	levier		
15	RPS-969/338	2	cuscinetto 9x24x7 zz	bearing	coussinet		
16	RPS-969/339	1	ingranaggio doppio	gear	engrenage		
17	RPS-969/012	1	rondella	washer	rondelle		
18	RPS-969/013	1	vite	screw	vis		
19	RPS-969/340	1	perno	pin	pivot		
20	RPS-969/018	1	rondella	washer	rondelle		
21	RPS-969/019	1	dado	nut	écrou		
22	RPS-969/341	1	anello di fermo	ring	anneau		
23	RPS-969/342	1	perno	pin	pivot		
24	RPS-969/020	1	dado	nut	écrou		
25	RPS-969/343	2	indice	index	indice		
26	RPS-969/344	1	righello	scale	règle		
27	RPS-969/345	1	supporto ribalt. porta coltello	support	support		

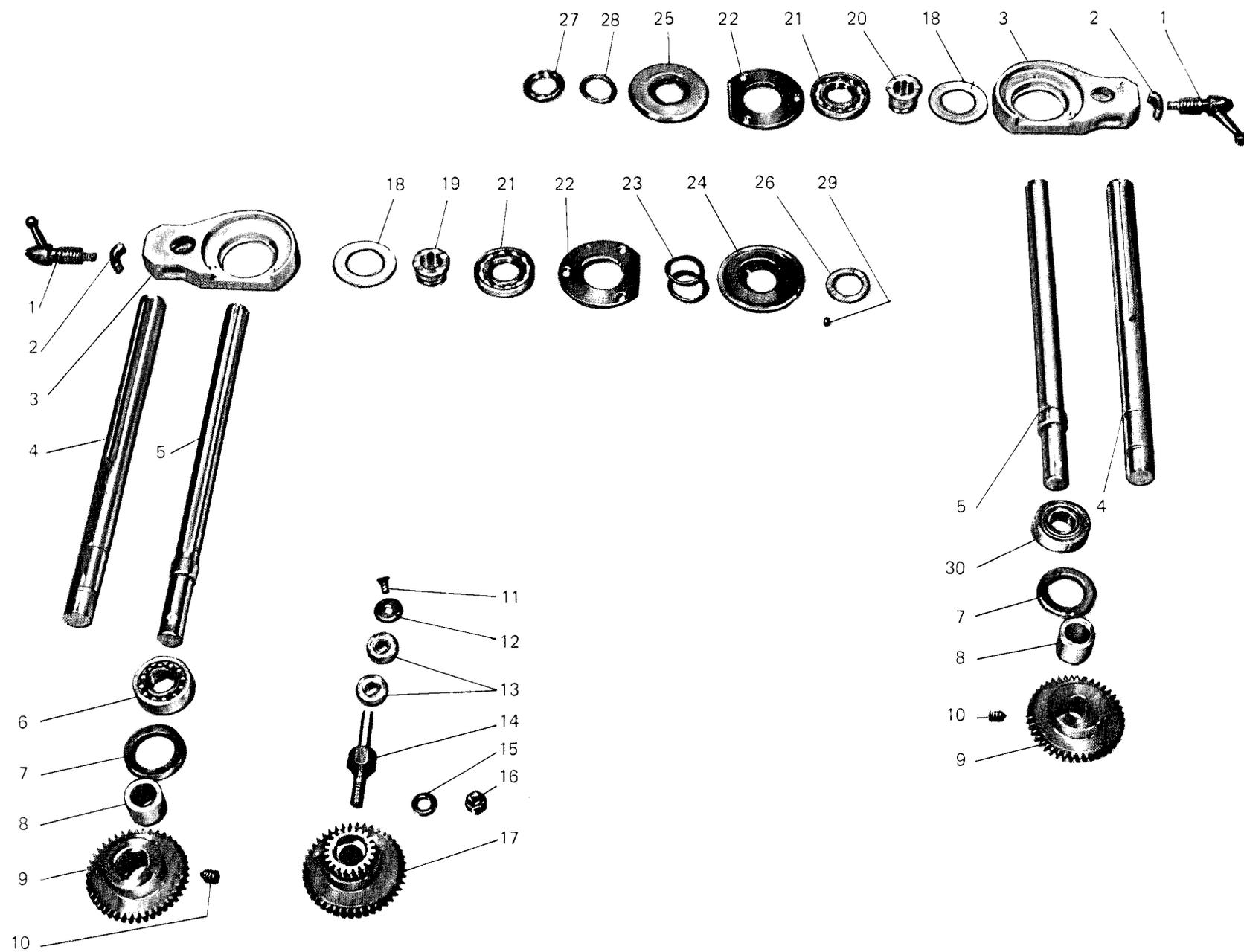

Fig. N. Abb. N.	Part. N. Bestell N. Pieça N. Pieza N.	Qt. Anzahl	DESCRIZIONE	DESCRIPTION	DESCRIPTION	BENENNUNG	DESCRIPCION
1	RPS-969/346	6	maniglia di bloccaggio	lever			
2	RPS-969/347	6	settore	sector	levier		
3	RPS-969/348	6	porta coltello oscillante	knife holder	secteur		
4	RPS-969/349	4	albero	shaft	porte-couteau		
5	RPS-969/350	4	albero	shaft	arbre		
6	RPS-969/351	2	cuscinetto oscillante 17x40x12	bearing	arbre		
7	RPS-969/352	4	coperchietto filettato	cover	coussinet		
8	RPS-969/353	4	distanziale	spacer	couvercle		
9	RPS-969/354	2	ingranaggio	gear	entretoise		
10	RPS-969/021	4	grano	screw	engrenage		
11	RPS-969/013	4	vite	screw	vis		
12	RPS-969/012	4	rondella	washer	vis		
13	RPS-969/355	2	cuscinetto 9x24x7	bearing	rondelle		
14	RPS-969/356	1	albero	shaft	coussinet		
15	RPS-969/018	1	rondella	washer	arbre		
16	RPS-969/019	1	dado	nut	rondelle		
17	RPS-969/357	1	ingranaggio doppio	gear	écrou		
18	RPS-969/358	6	anello posteriore	rear ring	engrenage		
19	RPS-969/359	3	bussola per coltello oscill.	bush	anneau arrière		
20	RPS-969/359/A	3	bussola per coltello fisso	bush	bague		
21	RPS-969/360	6	cuscinetto 25x47x8	bearing	bague		
22	RPS-969/361	6	coperchietto	cover	coussine		
23	RPS-969/362	6	anello	ring	couvercle		
24	RPS-969/363	3	coltello oscillante	knife	anneau		
25	RPS-969/364	3	coltello fisso	immovable knife	couteau		
26	RPS-969/365	3	ghiera filettata	ring nut	couteau fixe		
27	RPS-969/366	3	ghiera filettata	ring nut	collier		
28	RPS-969/367	3	distanziale per coltello fisso	spacer	collier		
29	RPS-969/368	3	spina	pin	entretoise		
30	RPS-969/290	2	cuscinetto 17x40x12 zz	bearing	goupille		
					coussinet		

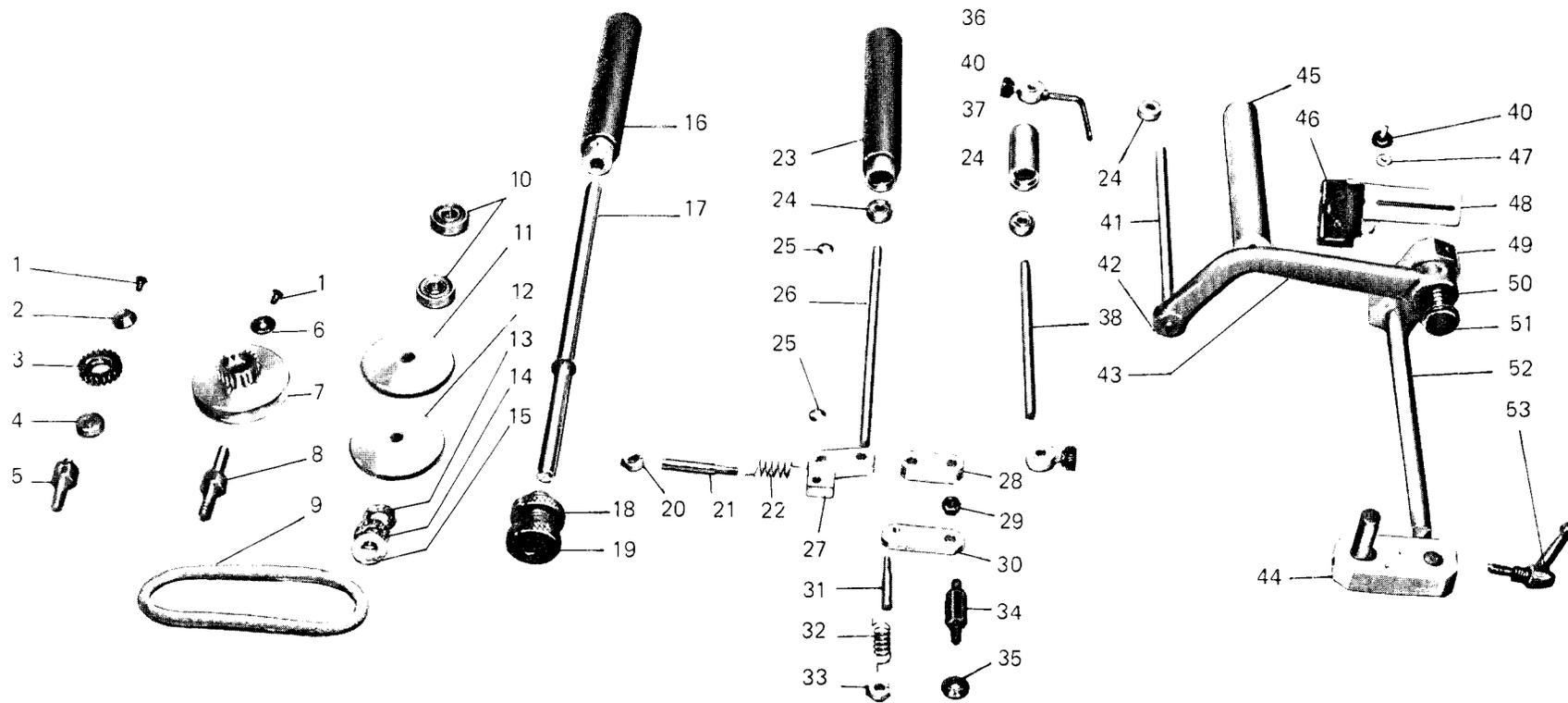

Fig. N. Abb. N.	Part. N. Piec. N. Bestell N. Pieza N.	Qt. Anzahl	DESCRIZIONE	DESCRIPTION	DESCRIPTION	BENENNUNG	DESCRIPCION
1	RPS-969/013	2	vite	screw	vis		
2	RPS-969/012	1	rondella	washer	rondelle		
3	RPS-969/369	1	ingranaggio	gear	engrenage		
4	RPS-969/370	3	cuscinetto 9x24x7	bearing	coussinet		
5	RPS-969/371	1	perno	pin	pivot		
6	RPS-969/012	1	rondella	washer	rondelle		
7	RPS-969/372	1	puleggia con ingranaggio	pulley	poulie		
8	RPS-969/373	1	perno	pin	pivot		
9	RPS-969/108	1	cinghia elastica	belt	courroie		
10	RPS-969/374	2	cuscinetto 12x32x10 zz	bearing	coussinet		
11	RPS-969/106	1	semi puleggia variatore sup.	half-pulley	semi-poulie		
12	RPS-969/109	1	semi puleggia variatore inf.	half-pulley	semi-poulie		
13 } 14 } 15 }	RPS-969/110	1	reggispinta	thrust	butée		
16	RPS-969/83	1	cilindro avvolgitore	cylinder	cyindre		
17	RPS-969/375	1	albero	shaft	arbre		
18	RPS-969/111	1	ghiera di bloccaggio	ring nut	collier		
19	RPS-969/112	1	volantino di regolazione	handwheel	volant		
20 } 21 } 22 }	RPS-969/376	2	anello di torsione	ring	anneau		
23 } 24 }	RPS-969/377	1	perno	pin	pivot		
25 } 26 }	RPS-969/378	2	molla a torsione	spring	ressort		
27	RPS-969/379	1	cilindro di gomma	cylinder	cyindre		
28	RPS-969/380	4	cuscinetto 8x22x7	bearing	coussinet		
29	RPS-969/381	2	anello	ring	anneau		
30	RPS-969/382	1	albero	shaft	arbre		
31	RPS-969/383	1	supporto porta rullo	support	support		
32	RPS-969/384	1	supporto	support	support		
33	RPS-969/019	1	dado	nut	écrou		
34	RPS-969/385	1	staffa	bracket	bride		
35	RPS-969/386	1	perno	pin	pivot		
36	RPS-969/387	1	perno	pin	pivot		
37	RPS-969/388	1	rondella	washer	rondelle		
38	RPS-969/389	1	anello regolabile con separatore	ring	anneau		
39	RPS-969/390	1	rullo	roller	rouleau		
40	RPS-969/391	1	alberino	shaft	arbre		
41	RPS-969/392	1	anello regolabile	ring	anneau		
42	RPS-969/393	3	pomolo	knob	pommeau		
43	RPS-969/394	1	albero porta rullo avvolgitore	shaft	arbre		
44	RPS-969/022	1	grano	screw	vis		
45	RPS-969/395	1	leva	lever	levier		
46	RPS-969/396	1	staffa	bracket	bride		
47	RPS-969/92	1	cilindro avvolgitore	cylinder	cyindre		
48	RPS-969/397	1	micro	micro	micro		

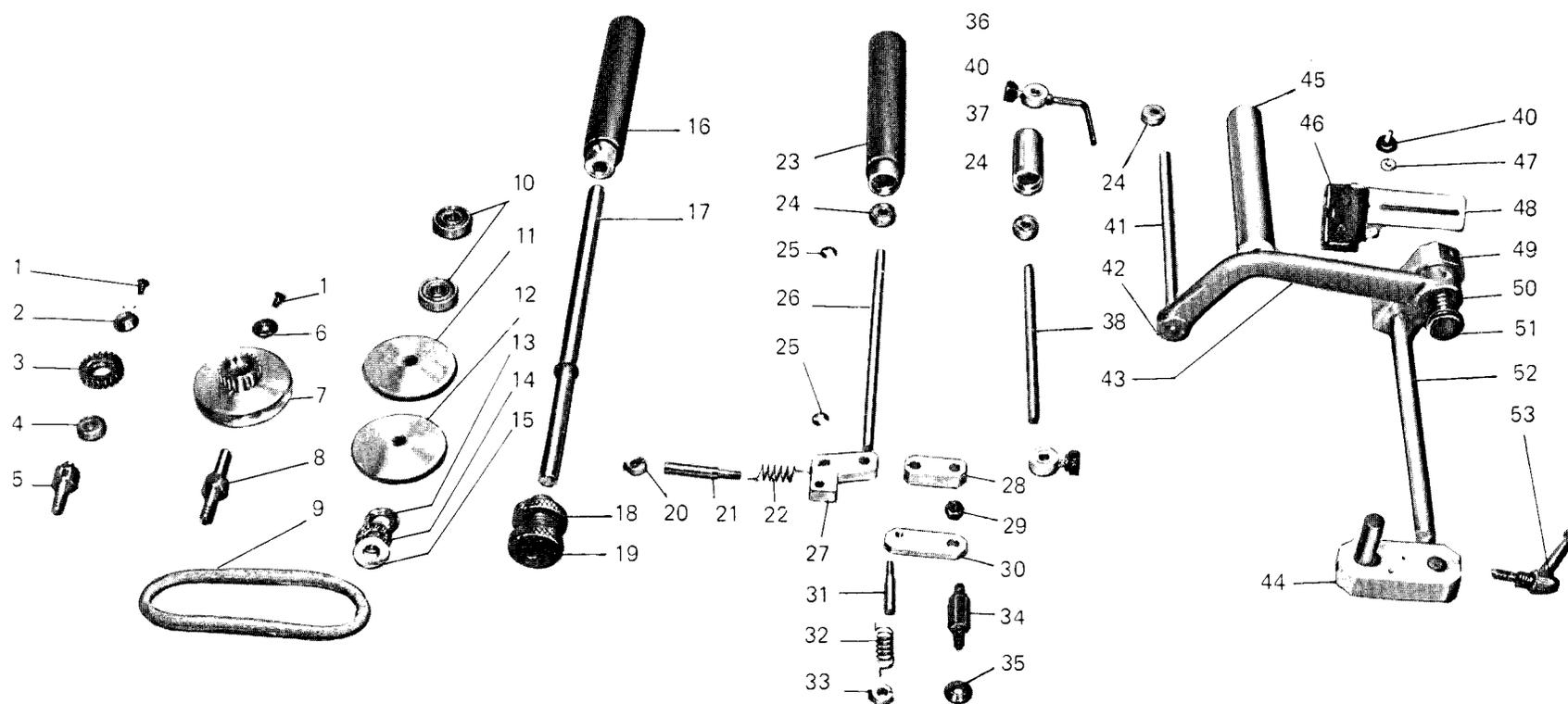

Fig. N. Abb. N.	Part. N. Bestell N. Piece N. Pieza N.	Qt. Anzahl	DESCRIZIONE	DESCRIPTION	DESCRIPTION	BENENNUNG	DESCRIPCION
47	RPS-969/023	1	rondella	washer	rondelle		
48	RPS-969/398	1	staffa porta micro	bracket	bride		
49	RPS-969/399	1	staffa	bracket	bride		
50	RPS-969/400	1	molla a torsione	spring	ressort		
51	RPS-969/401	1	perno	pin	pivot		
52	RPS-969/402	1	albero	shaft	arbre		
53	RPS-969/403	1	maniglia	lever	levier		

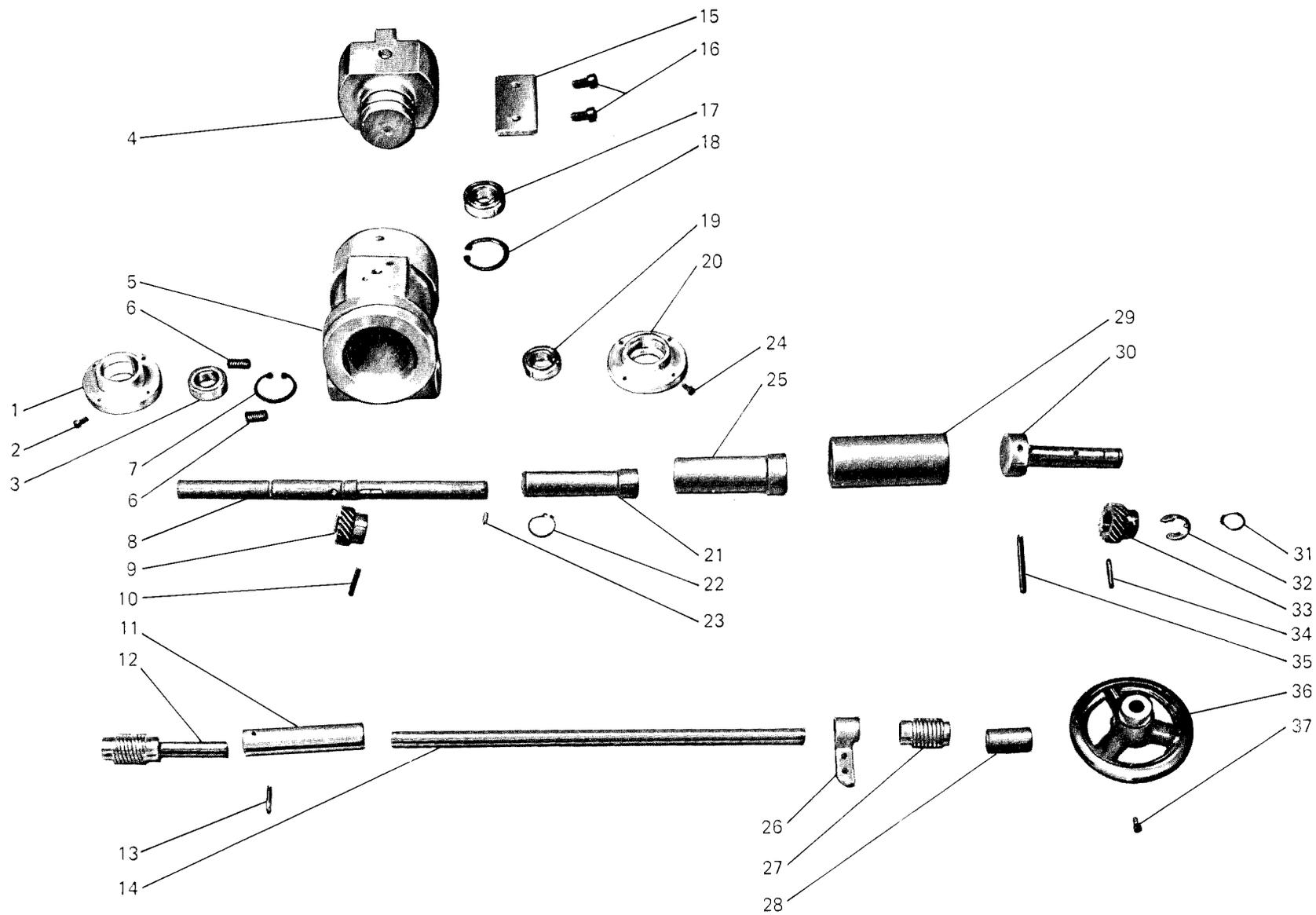

Fig. N. Abb. N.	Part. N. Pezze N. Bestell N. Pieza N.	Qt. Anzahl	DESCRIZIONE	DESCRIPTION	DESCRIPTION	BENENNUNG	DESCRIPCION
1	RPS-969/113	1	coperchio cuscinetto	bearing cover	couvercle coussinet		
2	RPS-969/052	4	vite	screw	vis		
3	RPS-969/1H	1	cuscinetto 17x35x10	bearing	coussinet		
4	RPS-969/114	1	supporto scorrevole	support	support		
5	RPS-969/115	1	supporto	support	support		
6	RPS-969/116	2	grano	screw	vis		
7	RPS-969/053	1	seeger	seeger	seeger		
8	RPS-969/117/1	1	albero com. rulli in gomma	shaft	arbre		
9	RPS-969/118	1	ingranaggio	gear	engrenage		
10	RPS-969/119	1	spina elastica	split pin	goupille réglable		
11	RPS-969/120/1	1	cannotto	column	fourche		
12	RPS-969/121	1	albero con vite senza fine	shaft with worm screw	arbre avec vis sans fin		
13	RPS-969/122	1	spina	pin	goupille		
14	RPS-969/123/1	1	albero con chiavetta	shaft with key	arbre avec clavette		
15	RPS-969/124	1	staffa	bracket	bride		
16	RPS-969/054	2	vite	screw	vis		
17	RPS-969/1J	1	cuscinetto 17x35x10	bearing	coussinet		
18	RPS-969/055	1	seeger	seeger	seeger		
19	RPS-969/1L	1	cuscinetto 17x35x10	bearing	coussinet		
20	RPS-969/125	1	coperchio	cover	couvercle		
21	RPS-969/126/1	1	bussola	bush	bage		
22	RPS-969/056	1	seeger	seeger	seeger		
23	RPS-969/127	1	grano	screw	vis		
24	RPS-969/057	4	vite	screw	vis		
25	RPS-969/127/1	1	bussola	bush	bage		
26	RPS-969/129	1	supporto	support	support		
27	RPS-969/130	1	vite senza fine con chiavetta	worm screw with key	vis sans fin avec clavette		
28	RPS-969/131	1	distanziale	spacer	entretoise		
29	RPS-969/132	1	bussola	bush	bage		
30	RPS-969/133	1	albero	shaft	arbre		
31	RPS-969/058	1	seeger	seeger	seeger		
32	RPS-969/059	1	seeger	seeger	seeger		
33	RPS-969/134	1	ingranaggio	gear	engrenage		
34	RPS-969/135	1	spina	pin	goupille		
35	RPS-969/136	1	spina	pin	goupille		
36	RPS-969/137	1	volantino	handwheel	volant		
37	RPS-969/060	1	grano	screw	vis		

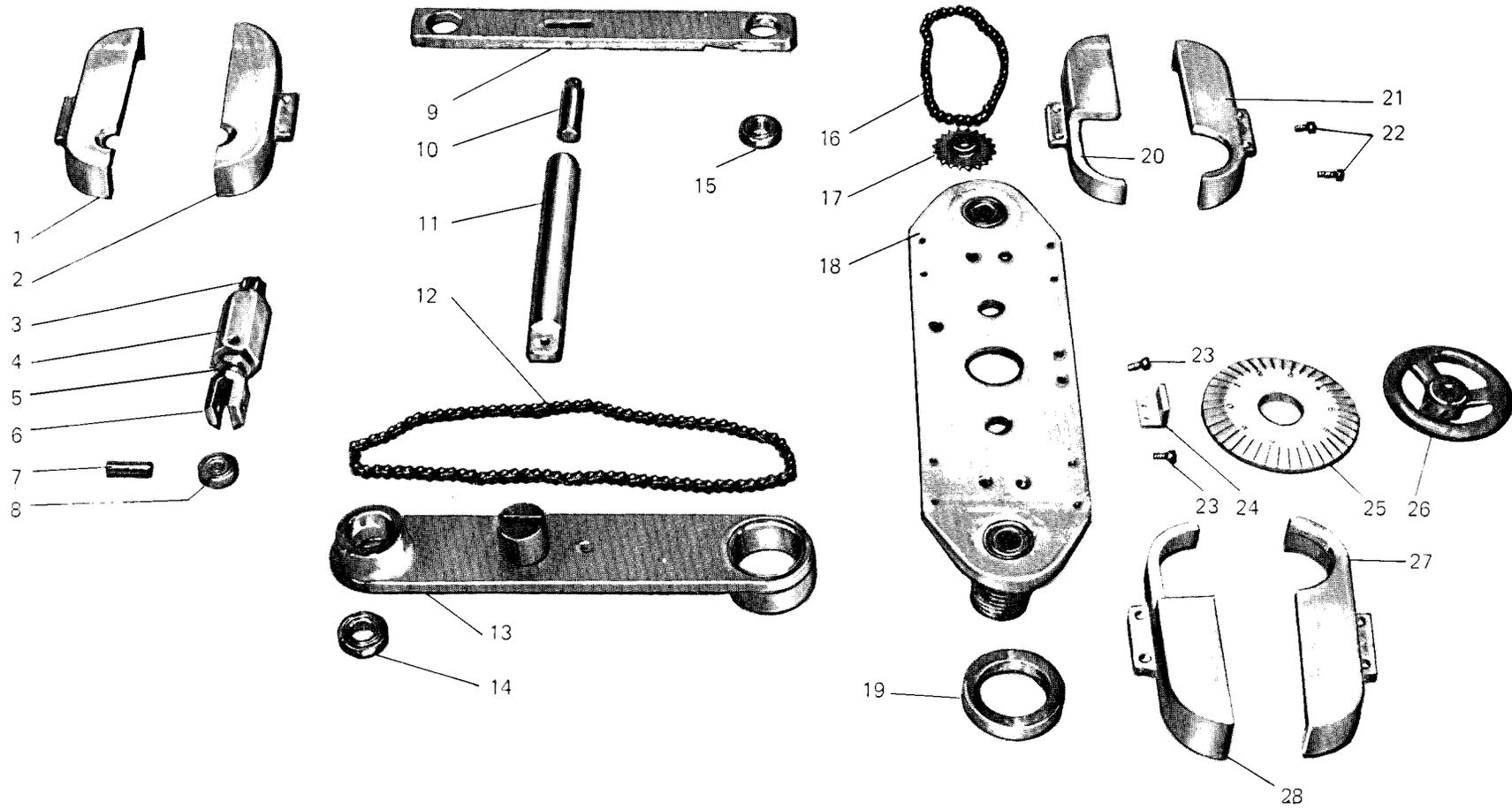

Fig. N. Abb. N.	Part. N. Piece N. Bestell N. Pieza N.	Qt. Anzahl	DESCRIZIONE	DESCRIPTION	DESCRIPTION	BENENNUNG	DESCRIPCION
1 } 2 }	RPS-969/404	2	carter di protezione	protection cover	carter de protection		
3	RPS-969/405	1	dado	nut	écrou		
4	RPS-969/406	1	perno	pin	pivot		
5	RPS-969/407	1	controdado	counter nut	contre-écrou		
6	RPS-969/408	1	supporto per cuscinetto	support for bearing	support pour coussinet		
7	RPS-969/409	1	perno	pin	pivot		
8	RPS-969/410	1	cuscinetto 10x30x9 zz	bearing	coussinet		
9	RPS-969/411	2	staffa di collegamento	bracket	bride		
10	RPS-969/412	2	perno	pin	pivot		
11	RPS-969/413	2	perno a cannocchiale	pin	pivot		
12	RPS-969/414	2	catena	chain	chaînette		
13	RPS-969/415	2	supporto	support	support		
14	RPS-969/416	4	cuscinetto 17x40x12 zz	bearing	coussinet		
15	RPS-969/417	4	cuscinetto oscill. 12x32x10	bearing	coussinet		
16	RPS-969/418	2	catena	chain	chaînette		
17	RPS-969/419	2	ingranaggio	gear	engrenage		
18	RPS-969/420	2	supporto	support	support		
19	RPS-969/421	2	anello di regolazione	ring	anneau		
20 } 21 }	RPS-969/422	1	carter posteriore	rear cover	carter arrière		
22 } 23 }	RPS-969/024	18	vite	screw	vis		
24	RPS-969/423	1	squadretta porta disco graduato	bracket	équerre		
25	RPS-969/424	1	disco graduato	disc	disque		
26	RPS-969/425	1	volantino	handwheel	volant		
27 } 28 }	RPS-969/426	1	carter anteriore	front cover	carter avant		

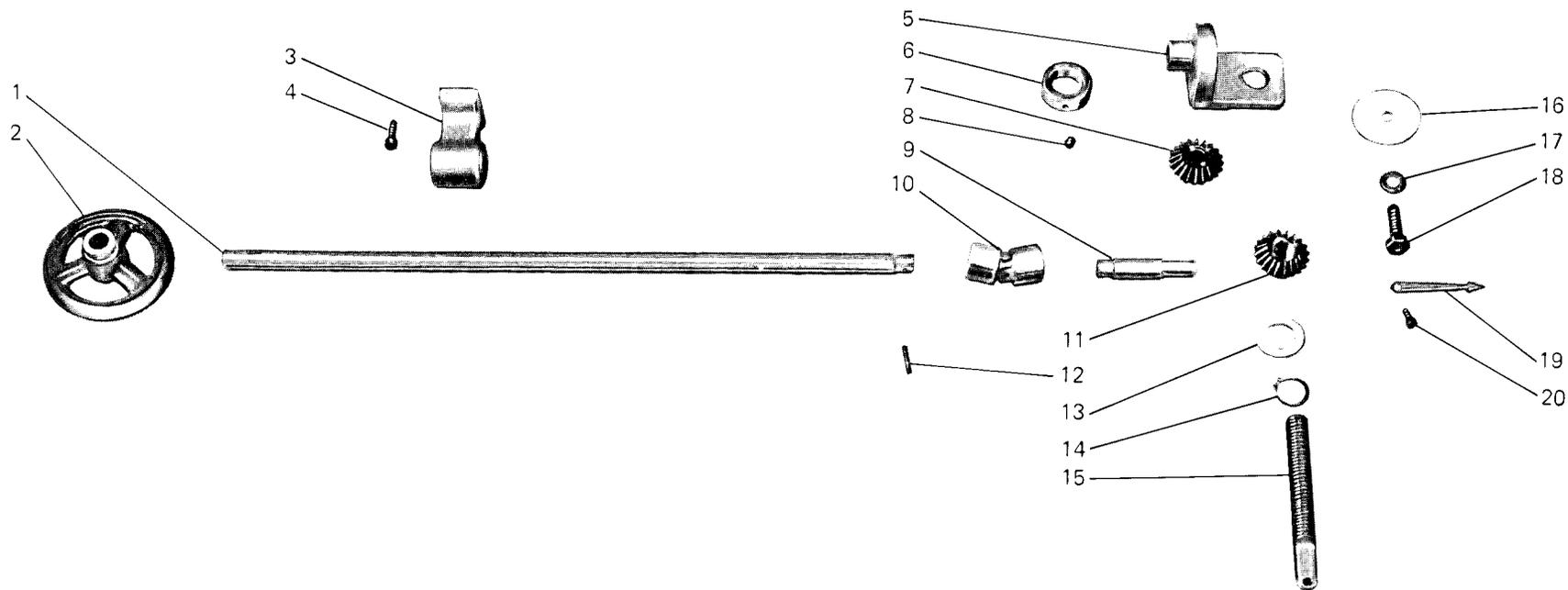

Fig. N. Abb. N.	Part. N. Bestell N. Piec N. Pieza N.	Qt. Anzahl	DESCRIZIONE	DESCRIPTION	DESCRIPTION	BENENNUNG	DESCRIPCION
1	RPS-969/166/1	1	albero com. variatore	shaft	arbre		
2	RPS-969/167	1	volantino	handwheel	volant		
3	RPS-969/168	1	supporto	support	support		
4	RPS-969/067	2	vite	screw	vis		
5	RPS-969/169	1	supporto	support	support		
6	RPS-969/170	1	anello di fermo	ring	anneau		
7	RPS-969/171	1	ingranaggio conico	gear	engrenage		
8	RPS-969/068	1	grano	screw	vis		
9	RPS-969/172	1	albero	shaft	arbre		
10	RPS-969/173	1	giunto cardanico	joint	joint		
11	RPS-969/174	1	ingranaggio conico	gear	engrenage		
12	RPS-969/175	2	spina	pin	goupille		
13	RPS-969/176	1	distanziale	spacer	entretoise		
14	RPS-969/069	1	seeger	seeger	seeger		
15	RPS-969/177	1	vite	screw	vis		
16	RPS-969/178	1	rondella	washer	rondelle		
17	RPS-969/070	1	rondella	washer	rondelle		
18	RPS-969/071	1	vite	screw	vis		
19	RPS-969/179	1	indice	index	indice		
20	RPS-969/072	1	vite	screw	vis		

Fig. N. Abb. N.	Part. N. Bestell N. Piece N. Pieza N.	Qt. Anzahl	DESCRIZIONE	DESCRIPTION	DESCRIPTION	BENENNUNG	DESCRIPCION
1	RPS-969/180	1	braccio sinistro	left arm		bras gauche	
2	RPS-969/073	5	vite	screw		vis	
3	RPS-969/181	2	innesto porta pezza	coupling		embrayage	
4	RPS-969/182	2	pomolo	knob		pommeau	
5	RPS-969/183/1	1	albero porta pezza	shaft		arbre	
6	RPS-969/184	2	albero per bracci	shaft		arbre	
7	RPS-969/074	1	dado	nut		écrou	
8	RPS-969/075	5	rondella	washer		rondelle	
9	RPS-969/185	2	supporto	support		support	
10	RPS-969/186	1	alberino	shaft		arbre	
11	RPS-969/187	1	innesto	coupling		embrayage	
12	RPS-969/1S	1	cuscinetto	bearing		coussinet	
13	RPS-969/188/1	1	traversa	tie		traverse	
14	RPS-969/189	2	settore	sector		secteur	
15	RPS-969/190	2	spina	pin		goupille	
16	RPS-969/190	2	spina	pin		goupille	
17	RPS-969/191	1	pomolo	knob		pommeau	
18	RPS-969/192	1	maniglia	lever		levier	
19	RPS-969/193	1	frizione	clutch		friction	
20	RPS-969/194	1	innesto albero	coupling		embrayage	
21	RPS-969/195	1	pomolo	knob		pommeau	
22	RPS-969/1T	1	cuscinetto	bearing		coussinet	
23	RPS-969/077	1	vite	screw		vis	
24	RPS-969/078	2	vite	screw		vis	
25	RPS-969/079	2	molla	spring		ressort	
26	RPS-969/196	2	pastiglia	plug		bouchon	
27	RPS-969/197	1	braccio destro	right arm		bras droite	

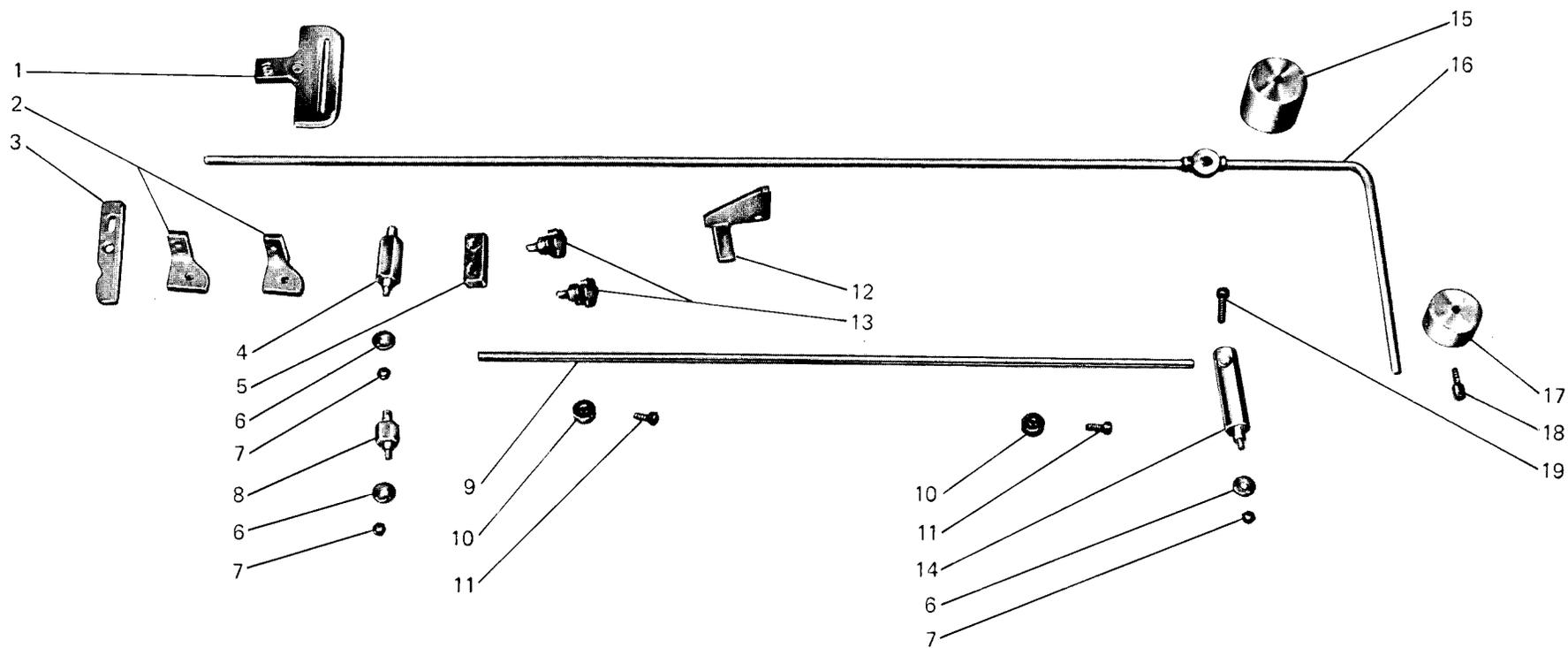

Fig. N. Abb. N.	Part. N. Bestell N. Pieca N. Pieza N.	Qt. Anzahl	DESCRIZIONE	DESCRIPTION	DESCRIPTION	BENENNUNG	DESCRIPCION
1	RPS-969/198	1	supporto scorrevole	sliding support		support coulissant	
2	RPS-969/199	2	supporto astina	support		support	
3	RPS-969/200	1	leva	lever		levier	
4	RPS-969/201/1	1	perno	pin		pivot	
5	RPS-969/202	1	supporto	support		support	
6	RPS-969/203	3	rondella	washer		rondelle	
7	RPS-969/080	3	dado	nut		écrou	
8	RPS-969/204	1	perno	pin		pivot	
9	RPS-969/205/1	1	astina	rod		tige	
10	RPS-969/206	2	anello di fermo	ring		anneau	
11	RPS-969/081	2	vite	screw		vis	
12	RPS-969/207	1	squadretta di arresto	bracket		équerre	
13	RPS-969/208	2	volantino	handwheel		volant	
14	RPS-969/209	1	perno	pin		pivot	
15	RPS-969/210	1	peso	weight		poids	
16	RPS-969/211/1	1	astina bilanciata	compensator rod		tige balancier	
17	RPS-969/212	1	peso	weight		poids	
18	RPS-969/082	1	vite	screw		vis	
19	RPS-969/083	1	vite	screw		vis	

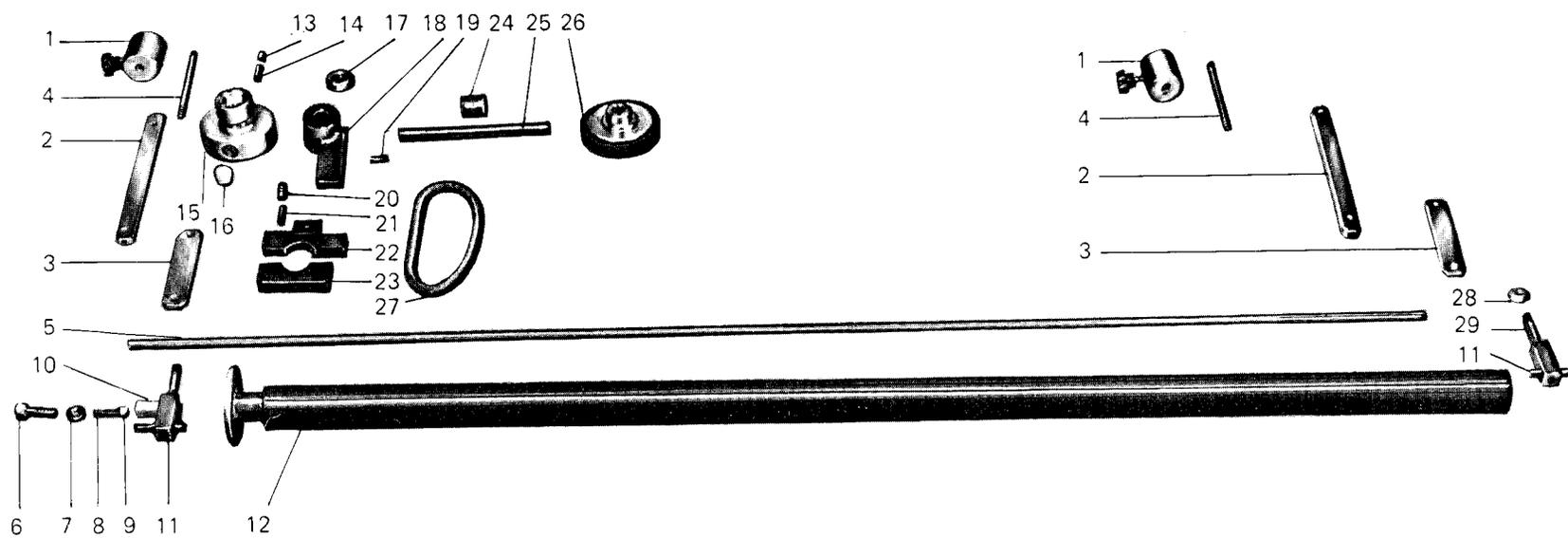

Fig. N. Abb. N.	Part. N. Bestell N. Pezza N. Pieza N.	Qt. Anzahl	DESCRIZIONE	DESCRIPTION	DESCRIPTION	BENENNUNG	DESCRIPCION
1	RPS-969/427	2	pesi	weight		poids	
2	RPS-969/428	2	staffe	bracket		bride	
3	RPS-969/429	2	staffe	bracket		bride	
4	RPS-969/430	2	astina porta pesi	rod		tige	
5	RPS-969/431/1	1	astina contrappeso	rod		tige	
6	RPS-969/432/1	1	pomolo di regolazione	knob		pommeau	
7	RPS-969/433/1	1	ghiera di bloccaggio	ring nut		collier	
8	RPS-969/434/1	1	molla	spring		ressort	
9	RPS-969/435/1	1	pastiglia di frenaggio	plug		bouchon	
10	RPS-969/436/1	1	supporto sinistro	left support		support gauche	
11	RPS-969/437/1	2	perno	pin		pivot	
12	RPS-969/438/1	1	rullo gommato	roller		rouleau	
13	RPS-969/021	1	grano	screw		vis	
14	RPS-969/439	1	molla	spring		ressort	
15	RPS-969/440	1	disco con puleggia	disc with pulley		disque avec poulie	
16	RPS-969/441	1	pastiglia di frenaggio	plug		bouchon	
17	RPS-969/442	2	cuscinetto 12x28x8	bearing		coussinet	
18	RPS-969/443	1	supporto	support		support	
19	RPS-969/444	1	spina	pin		goupille	
20	RPS-969/022	1	grano	screw		vis	
21	RPS-969/445	1	molla	spring		ressort	
22	RPS-969/446	1	supporto con cava	support		support	
23	RPS-969/447	1	coperchio per supporto	cover for support		couvercle pour support	
24	RPS-969/448	1	distanziale	spacer		entretoise	
25	RPS-969/449	1	albero	shaft		arbre	
26	RPS-969/450	1	ruota gommata	wheel		roue	
27	RPS-969/108	1	cinghia	belt		courroie	
28	RPS-969/451	2	rondella	washer		rondelle	
29	RPS-969/452	1	supporto destro	right support		support droite	

Fig. N. Abb. N.	Part. N. Piece N. Bestell N. Pieza N.	Qt. Anzahl	DESCRIZIONE	DESCRIPTION	DESCRIPTION	BENENNUNG	DESCRIPCION
1	RPS-969/216	4	anello bloccaggio	ring	anneau		
2	RPS-969/1U	3	cuscinetto	bearing	coussinet		
3	RPS-969/217	1	puleggia	pulley	poulie		
4	RPS-969/086	6	vite	screw	vis		
5	RPS-969/218/1	1	astina	rod	tige		
6	RPS-969/219	1	molla	spring	ressort		
7	RPS-969/220	1	alberino superiore	upper shaft	arbre supérieur		
8	RPS-969/221	1	cinghia	belt	courroie		
9	RPS-969/222	1	innesto nottolino	powl coupling	embrayage axe		
10	RPS-969/223	1	disco porta innesto	disc	disque		
11	RPS-969/224	1	ingranaggio	gear	engrenage		
12	RPS-969/225	1	albero	shaft	arbre		
13	RPS-969/1V	2	cuscinetto	bearing	coussinet		
14	RPS-969/226	1	supporto	support	support		
15	RPS-969/227	1	dado	nut	écrou		
16	RPS-969/228	1	bilanciere	compensator	balancier		
17	RPS-969/087	1	dado	nut	écrou		
18	RPS-969/088	1	rondella	washer	rondelle		
19	RPS-969/229	1	perno	pin	pivot		
20	RPS-969/230	1	nottolino	powl	axe		
21	RPS-969/231	1	molletta	spring	ressort		
22	RPS-969/232	1	ingranaggio superiore	upper gear	engrenage supérieur		
23	RPS-969/233/1	1	braccio	arm	bras		
24	RPS-969/089	1	rondella elastica	spring washer	rondelle élastique		
25	RPS-969/234	1	staffa	bracket	équerre		
26	RPS-969/235	1	alberino	shaft	arbre		
27	RPS-969/236	1	disco gommato	disc	disque		
28	RPS-969/237	1	supporto	support	support		
29	RPS-969/238	1	forcella	fork	fourche		
30	RPS-969/090	2	vite	screw	vis		
31	RPS-969/091	2	vite	screw	vis		
32	RPS-969/239	2	anello	ring	anneau		
33	RPS-969/240	2	perno a sfera	ball joint	pivot à sphère		
34	RPS-969/241	1	sostegno	support	support		
35	RPS-969/242	1	dado	nut	écrou		
36	RPS-969/243	1	attacco	coupling	raccord		
37	RPS-969/244/1	1	bilanciere	compensator	balancier		

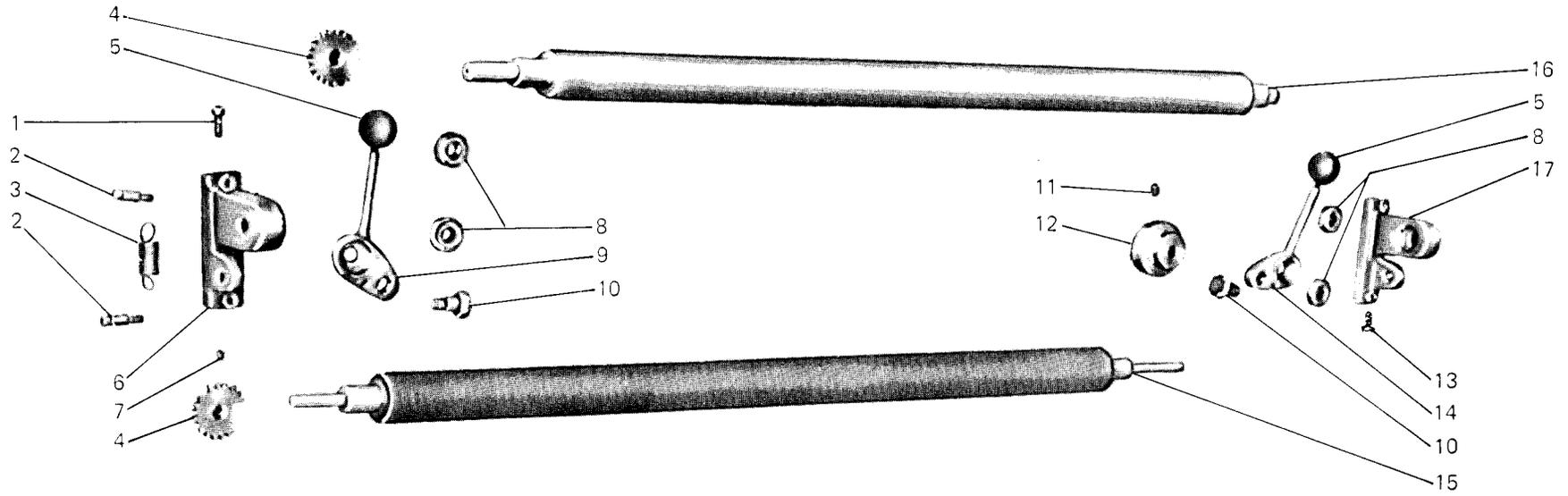

Fig. N. Abb. N.	Part. N. Piece N. Bestell N. Pieza N.	Qt. Anzahl	DESCRIZIONE	DESCRIPTION	DESCRIPTION	BENENNUNG	DESCRIPCION
1	RPS-969/092	2	vite	screw	vis		
2	RPS-969/245	4	perno	pin	pivot		
3	RPS-969/246	2	molla	spring	ressort		
4	RPS-969/247	2	ingranaggio	gear	engrenage		
5	RPS-969/248	2	pomolo	knob	pommeau		
6	RPS-969/249	1	supporto sinistro	left support	support gauche		
7	RPS-969/093	2	vite	screw	vis		
8	RPS-969/1W	4	cuscinetto	bearing	coussinet		
9	RPS-969/250	1	supporto mobile sinistro	left movable support	support mobile gauche		
10	RPS-969/251	2	vite a perno	screw	vis		
11	RPS-969/094	1	vite	screw	vis		
12	RPS-969/252	1	puleggia	pulley	poulie		
13	RPS-969/095	2	vite	screw	vis		
14	RPS-969/253	1	supporto mobile destro	right movable support	support mobile droite		
15	RPS-969/254/1	1	rullo	roller	rouleau		
16	RPS-969/255/1	1	rullo	roller	rouleau		
17	RPS-969/256	1	supporto destro	right support	support droite		

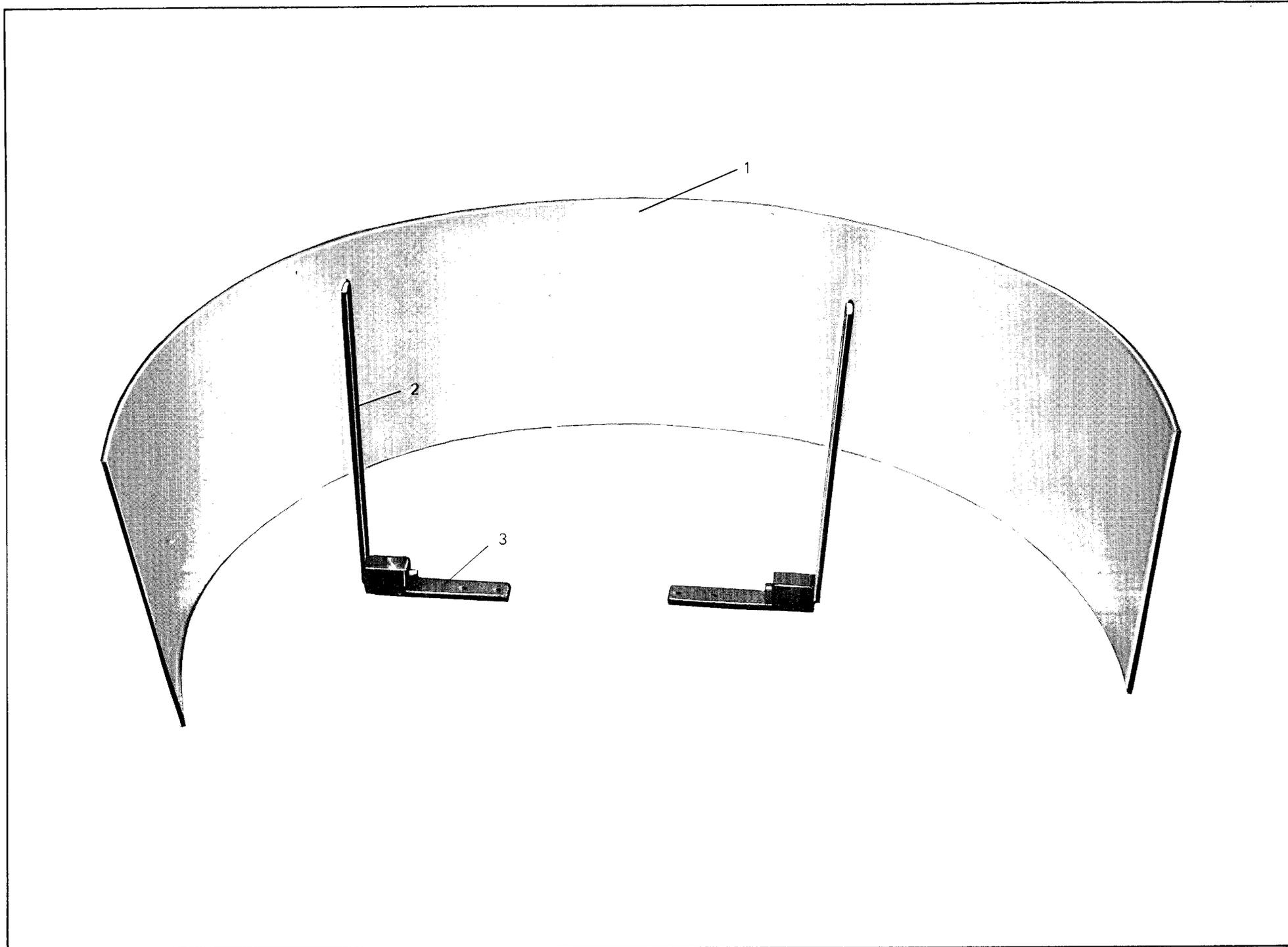

Fig. N. Abb. N.	Part. N. Bestell N. Piece N. Pieza N.	Qt. Anzahl	DESCRIZIONE	DESCRIPTION	DESCRIPTION	BENENNUNG	DESCRIPCION
1	RPS-969/453	1	protezione posteriore in plexiglas	rear protection	protection arrière		
2	RPS-969/454	2	supporto porta protezione	support	support		
3	RPS-969/454	2	supporto	support	support		

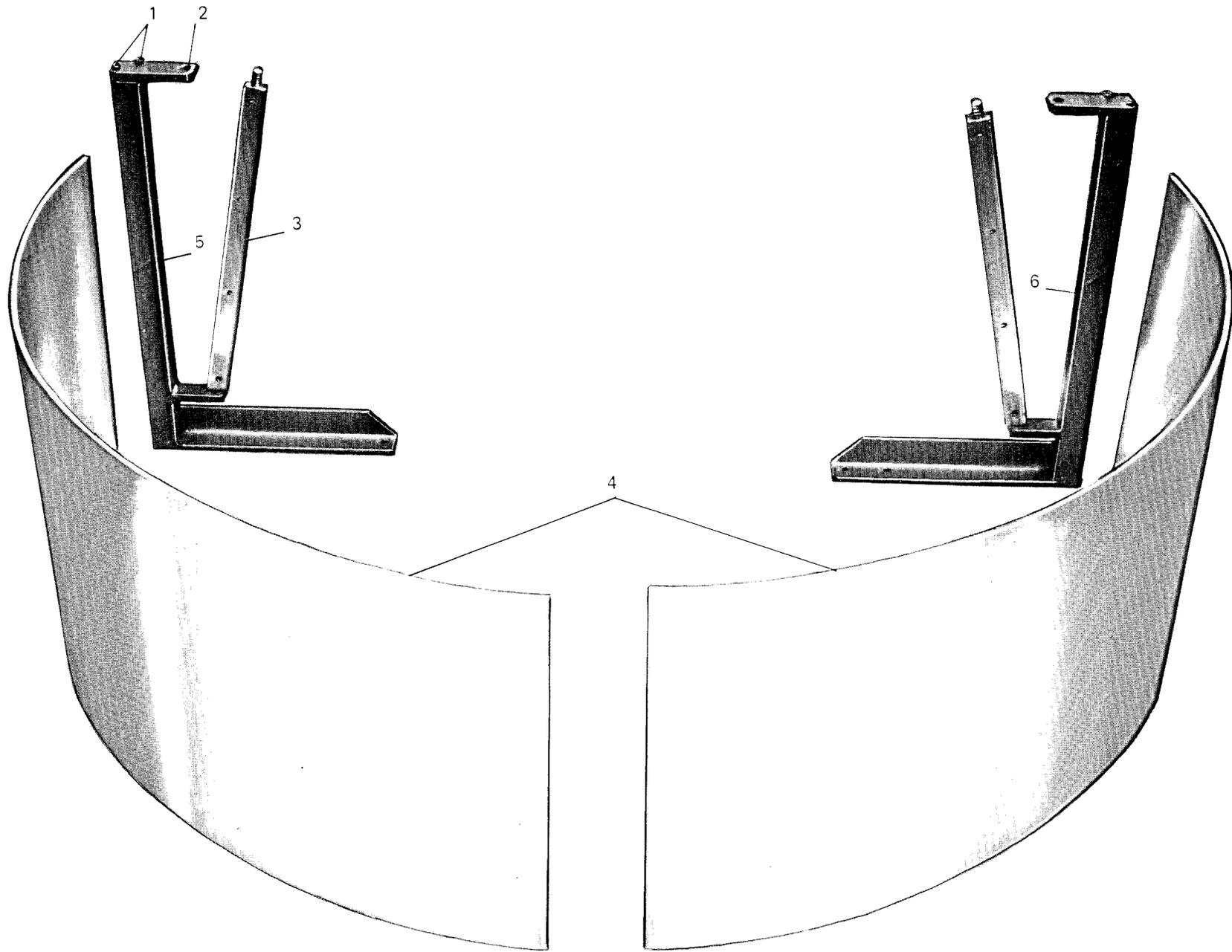

Fig. N. Abb. N.	Part. N. Bestell N. Pieca N. Pieza N.	Qt. Anzahl	DESCRIZIONE	DESCRIPTION	DESCRIPTION	BENENNUNG	DESCRIPCION
1	RPS-969/026	4	vite	screw		vis	
2	RPS-969/455	2	supporto superiore	upper support		support supérieur	
3	RPS-969/456	2	staffa	bracket		bride	
4	RPS-969/457	2	semiripari anteriore	front half-protection		semi-protection avant	
5	RPS-969/458	1	supporto sinistro	left support		support gauche	
6	RPS-969/459	1	supporto destro	right support		support droite	

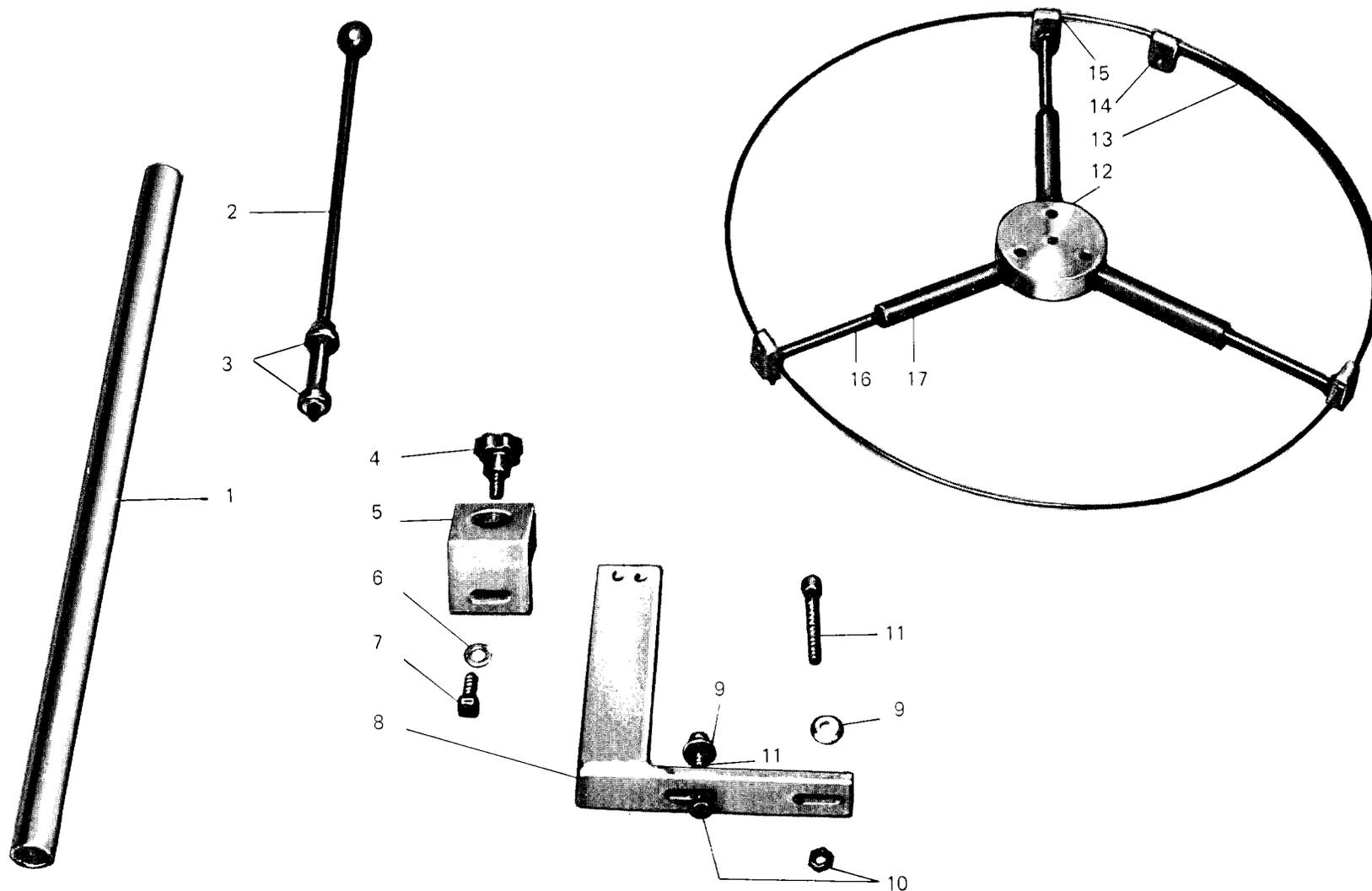

Fig. N. Abb. N.	Part. N. Bestell N. Piece N. Pieza N.	Ct. Anzahl	DESCRIZIONE	DESCRIPTION	DESCRIPTION	BENENNUNG	DESCRIPCION
1	RPS-969/460	1	tubo sostegno giostrino	pipe	tube		
2	RPS-969/461	1	albero	shaft	arbre		
3	RPS-969/462	2	cuscinetto 8x22x7	bearing	coussinet		
4	RPS-969/463	1	pomolo	knob	pommeau		
5	RPS-969/464	1	supporto	support	support		
6	RPS-969/025	1	rondella	washer	rondelle		
7	RPS-969/026	1	vite	screw	vis		
8	RPS-969/465	1	supporto di base	support	support		
9	RPS-969/466	2	rondella	washer	rondelle		
10	RPS-969/019	1	dado	nut	écrou		
11	RPS-969/027	2	vite	screw	vis		
12	RPS-969/467	1	supporto centrale	support	support		
13	RPS-969/468	1	cerchio regolabile	circle	cercle		
14	RPS-969/469	2	morsetto regolabile	clamp	collier de serrage		
15	RPS-969/470	2	morsetto regolabile	clamp	collier de serrage		
16	RPS-969/471	3	razza regolabile	arm	bras		
17	RPS-969/472	3	supporto a cannocchiale	support	support		

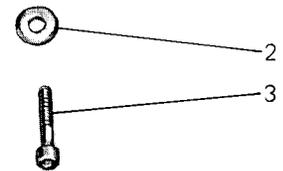
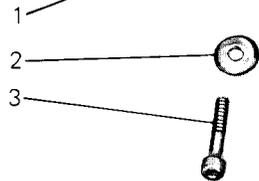
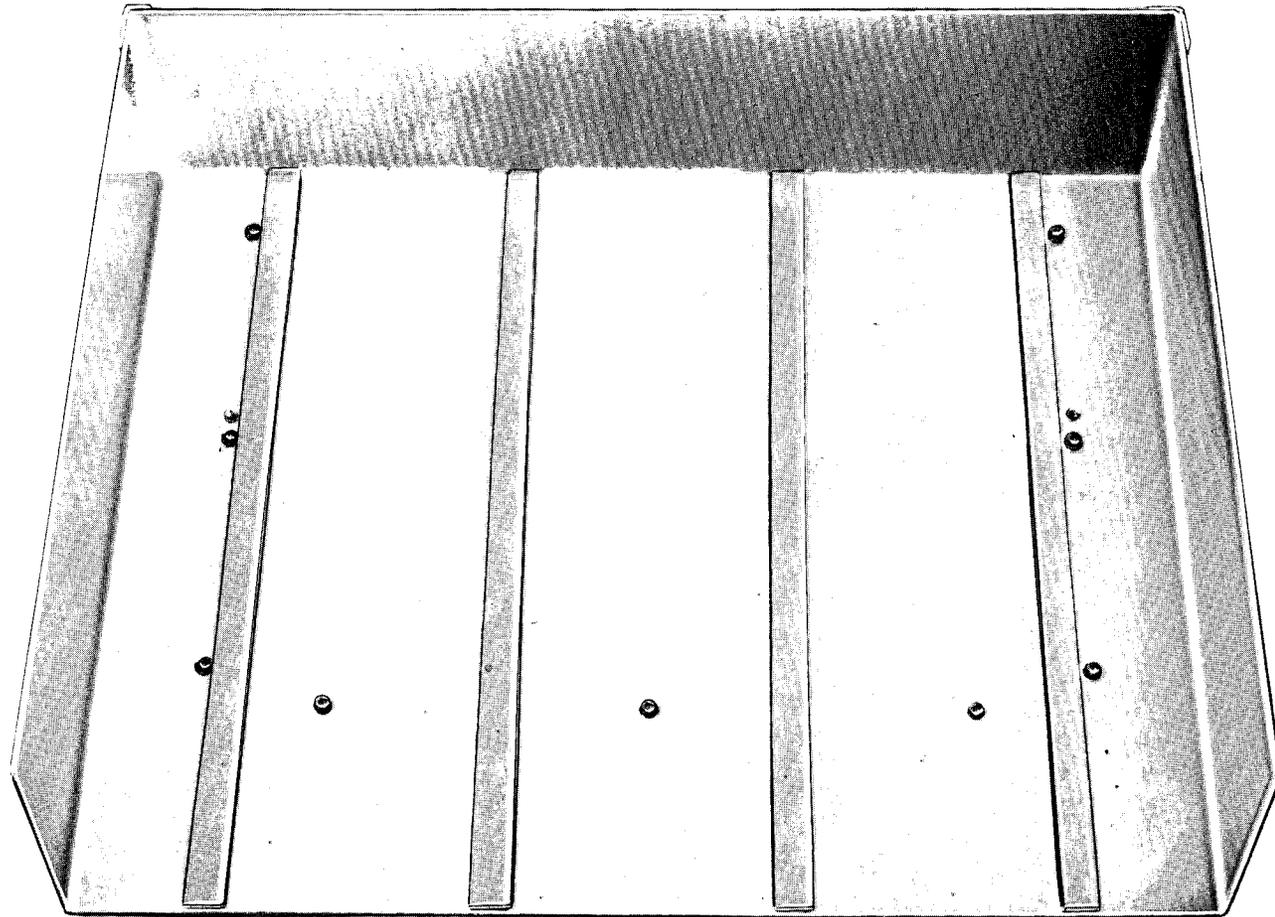

Fig. N. Abb. N.	Part. N. Piece N. Bestell N. Pieza N.	Qt. Anzahl	DESCRIZIONE	DESCRIPTION	DESCRIPTION	BENENNUNG	DESCRIPCION
1	RPS-969/261/1	1	contenitore	container	container		
2	RPS-969/262	2	rondella	washer	rondelle		
3	RPS-969/0100	2	vite	screw	vis		

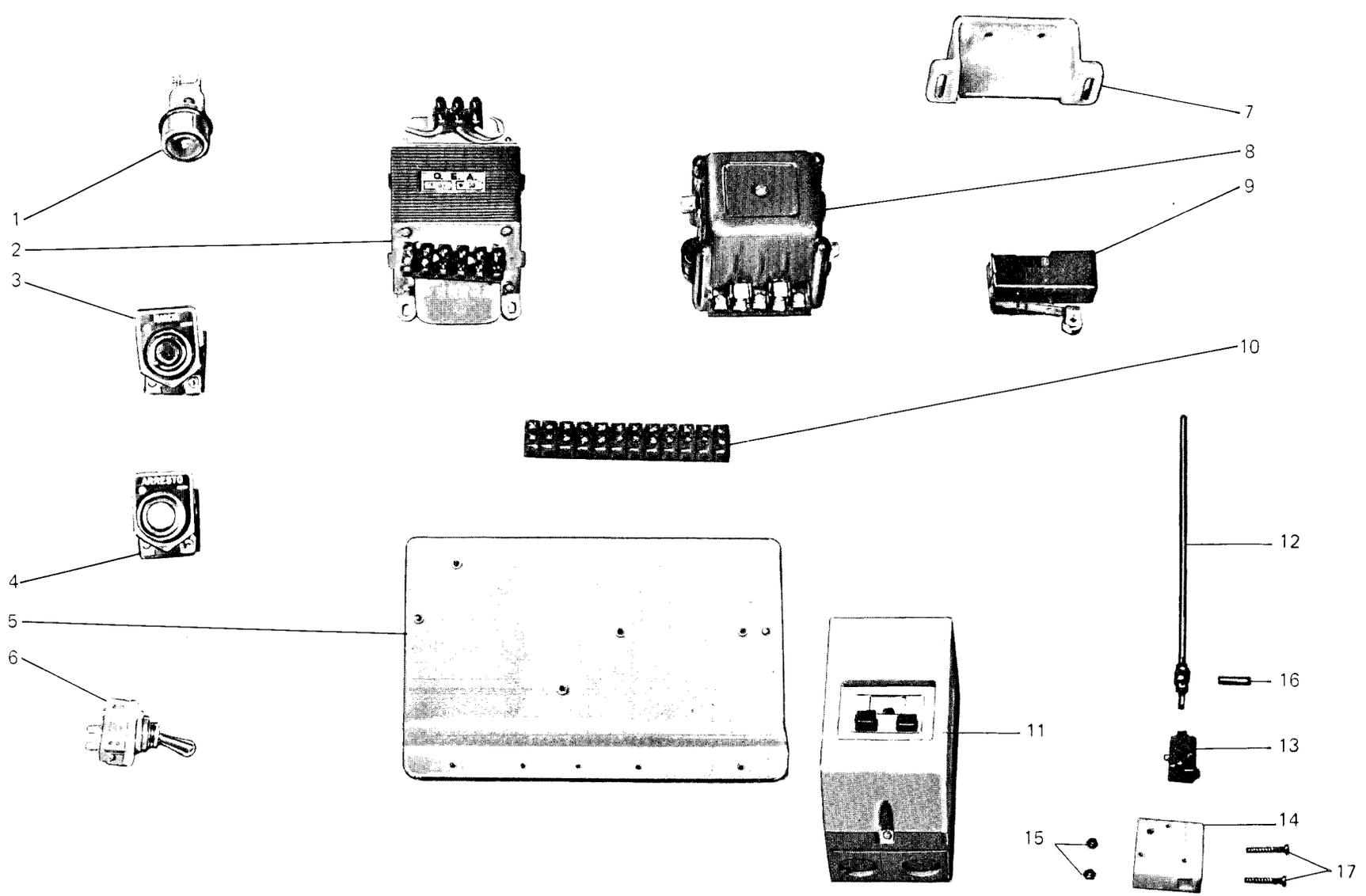

Fig. N. Abb. N.	Part. N. Bestell N. Pieze N.	Qt. Anzahl	DESCRIZIONE	DESCRIPTION	DESCRIPTION	BENENNUNG	DESCRIPCION
1	RPS-969/263	1	lampada spia	lamp	lampe		
2	RPS-969/264	1	trasformatore 30W	transformer	transformateur		
3	RPS-969/265	1	pulsante marcia	push-button	poussoir		
4	RPS-969/266	1	pulsante arresto	push-button	poussoir		
5	RPS-969/267	1	piastra	plate	plaque		
6	RPS-969/268	1	interruttore	switch	interrupteur		
7	RPS-969/269	1	protezione microinterruttore	microswitch protection	protection micro-interrupteur		
8	RPS-969/270	1	teleruttore T6-8-24V	electromagnetic switch	télerupteur		
9	RPS-969/271	1	microinterruttore	microswitch	micro-interrupteur		
10	RPS-969/272	1	morsettiera	junction box	plaque à bornes		
11	RPS-969/273/1	1	interruttore	switch	interrupteur		
12	RPS-969/275	1	asta comando micro	rod	tige		
13	RPS-969/276	1	microinterruttore di sicurezza	microswitch	micro-interrupteur		
14	RPS-969/277	1	protezione	protection	protection		
15	RPS-969/278	2	dado	nut	écrou		
16	RPS-969/279	1	spina	pin	goupille		
17	RPS-969/280	2	vite	screw	vis		