

ARCHIVIO

CATALOGO PROVVISORIO

171-10-2MD-04

Allegare al Cat. 102/A

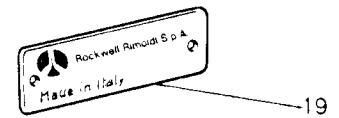
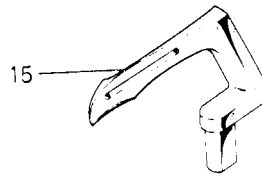
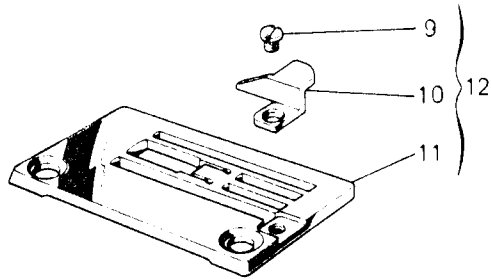
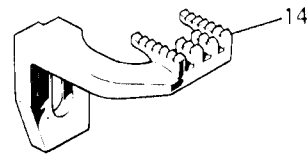
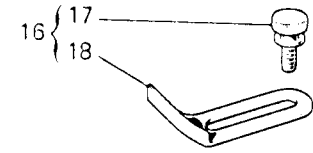
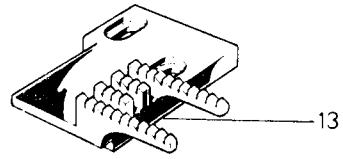
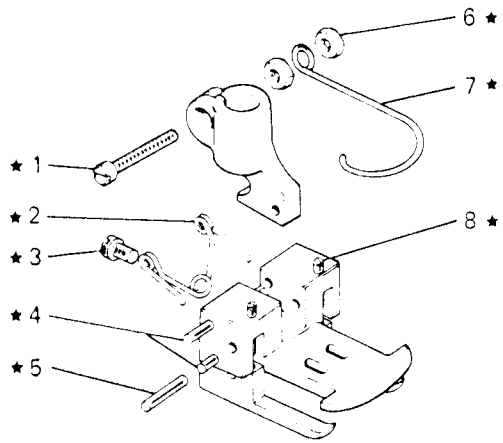

Fig. N. Abb. N.	Part. N. P. N. Design. N. Part. N.	Qt. Anzahl	DESCRIZIONE	DESCRIPTION	DESCRIPTION	BENENNUNG	DESCRIPCION
★	306611-3-00	1	piedino completo	presserfoot assembly	pied-presseur complet		
1	741781-2-00	1	vite	screw	vis		
2	300291-0-11	1	molla	spring	ressort		
3	741620-2-00	1	vite	screw	vis		
4	300289-0-10	2	spina	pin	goupille		
5	706431-0-00	1	spina	pin	goupille		
6	733504-2-00	2	dado	nut	écrou		
7	990808-0-01	1	salvadita	protection	protection		
8	306688-0-00	2	spina	pin	goupille		
9	300952-0-10	1	vite	screw	vis		
10	302513-0-10	1	guida	guide	guide		
11	302509-0-10	1	placca ago	needle plate	plaque à aiguille		
12	302510-4-10	1	placca ago completa	needle plate assembly	plaque à aiguille complète		
13	311261-0-00	1	griffa principale	main feed dog	griffe principale		
14	302491-0-11	1	griffa differenziale	differential feed dog	griffe différentielle		
15	302057-0-12	1	crochet inferiore	lower looper	crochet inférieur		
16	310015-4-00	1	guida completa	guide assembly	guide complet		
17	300917-0-10	2	pomolo	knob	pommeau		
18	302586-0-10	1	guida	guide	guide		
19	780200-0-30	1	targhetta classe testa	head class plate	plaque classe tête		
			SOLO A RICHIESTA	ONLY ON REQUEST	SEULEMENT SUR DEMANDE		
10	302623-0-00	1	guida	guide	guide		
11	302497-0-11	1	placca ago	needle plate	plaque à aiguille		
12	302626-4-00	1	placca ago completa	needle plate assembly	plaque à aiguille complète		
16	310006-4-00	1	guida completa	guide assembly	guide complet		
18	300919-0-10	1	guida	guide	guide		